



## MARINE DISTRESS SIGNALS



### LIFESMOKE MK9



Compact, flat-top day-time orange smoke distress signal providing effective position marking or indication of wind direction during rescue operations.

Code: MM PSW 9537000



### MANOVERBOARD MK9



Combined light and smoke Man Overboard Lifebuoy marker.

Code: MM PSW 9537800



### LINETHROWER 250



Self-contained rocket propelled linethrowing appliance.

Code: MM PSW 50200



### LINETHROWER 250 ROCKET



Linethrower 250 replacement Rocket.

Code: MM PSW 50080



### LINETHROWER 250 BODY AND LINE



MED & SOLAS Approved linethrower. Plastic line container with integral striker. 250 m of 4 mm Ø line.

Code: MM PSW 50070



### BUOYSMOKE MK8



Man overboard Lifebuoy Marker. Produces 15 minutes of orange smoke without light system.

Code: MM PSW 53830



### RED HANDFLARE MK8



Unique, compact, telescopic handle allows easy extension for sale operation and saves space in stowage. Short range distress signal.

Code: MM PSW 52900



### PARA RED ROCKET MK8A



Para Red Rocket conforms to SOLAS 74/88. A long range distress signal.

Code: MM PSW 50672



**LARGE POLYBOTTLE**

12 litre Polybottle - Waterproof storage bottle for flares.

Code: MM PSW 9569000

**SIGNAL PISTOL CALIBRE 4 (26,5 MM)**

Signal Pistol Calibre 4 (26,5 mm). Classified as firearm can be used for flare stack lighting.

Code: MM PSW 9129300

**PARACHUTE SIGNAL CARTRIDGE CAL.4/26.5MM**

For signal pistol calibre 4 (26,5 mm)

Code: MM PSW 9122600 (red parachute)  
MM PSW 9122700 (white parachute)  
MM PSW 9122500 (maroon)

**COMPACT DISTRESS SIGNAL**

Aerial distress signalling kit. Contains 3 red cartridges and an integral launcher.

Code: MM PSW 55666

**WHITE HANDFLARE MK8**

Designed for use as a collision warning signal or for illuminating small areas where an intense white light is required. Features a unique telescopic handle which makes the signal compact and saves space in stowage.

Code: MM PSW 52751

**PARACHUTE ILLUMINATING ROCKET MK8**

The parachute illuminating rocket is used in search and rescue operations at night or for collision warning.

Code: MM PSW 50755

**GRAB BAG**

Buoyant, splash-proof emergency bag to store your safety equipment.

Code: MM PSW 87-400

**SIGNAL CARTRIDGE CALIBRE 4 (26.5MM)**

Red cartridge = distress signal  
White cartridge = collision warning  
Green cartridge = general signalling

Code: MM PSW 9182000 (red)  
MM PSW 9182100 (white)  
MM PSW 9182200 (green)

**HANDSMOKE MK8A**

Daytime, hand-held distress signal. Produces dense orange smoke for 60 seconds.

Code: MM PSW 53930

**PERSONAL DISTRESS SIGNAL**

Aerial distress signalling kit. Contains 9 red cartridges and a launcher.

Code: MM PSW 55665

**MINI POLYBOTTLE**

Mini Polybottle (water resistant) 3 litre capacity. For flares storage.

Code: MM PSW 9870050

**DAY AND NIGHT MK8**

Compact, hand held distress signal consisting of a red flare at one end and an orange smoke at the other.

Code: MM PSW 55970

MANSUETO MARINE

Technical data sheets for both SOLAS (Commercial) and Non-SOLAS (Leisure & Aviation) distress signals available on request.

## You need to get rid of your expired signals?

Our Safety Department can take them back and arrange their disposal in compliance with the current environmental regulations.  
A Certificate declaring the accomplishment of a safe disposal service will be issued.

**BLACK INFLATABLE BALL Ø 400 mm**

Does not occupy space when deflated; to be hoisted when the boat is anchored; if there is no steering 2 balls shall be mounted.

Code: MM OSC 3065400

**BLACK SIGNAL BALL Ø 300 mm**

Made of anti-glare black polycarbonate, to be hoisted during day light when the boat is anchored; if there is no steering 2 balls shall be mounted vertically.

1 - at anchor  
2 - no steering  
3 - aground  
4 - danger (using any square flag)

Code: MM OSC 3065000

**BLACK SIGNAL CONE HEIGHT 470 mm**

Made of anti-glare black polycarbonate, designed to be fitted onto the bow when the boat navigates simultaneously using the sail and the motor. Sail and motor propulsion.

Code: MM OSC 3065100

**MIRROR SIGNAL HELIOGRAPH Ø 85MM**

Made of shatter-proof chromed plastic.

Codes: MM OSC 3063000FR Instruction language French  
MM OSC 3063000IT Instruction language Italian  
MM OSC 3063000SP Instruction language Spanish

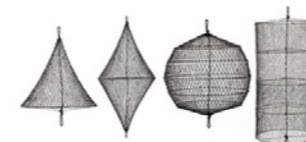
**NET TYPE DAY-MARK SIGNALS**

Codes: MM VEL 03090/RETE  
MM VEL 03091/RETE  
MM VEL 03092/RETE  
MM VEL 03093/RETE

Black signal cone H. 620mm  
Black signal bi-cone H. 620mm  
Black signal ball Ø 620mm  
Black signal sphere H. 620mm

## GET APP!



Download our App and get your quote within 24 hours!

www.mansuetomarine.it

## SART

### mcmurdo

#### S4 RESCUE SART

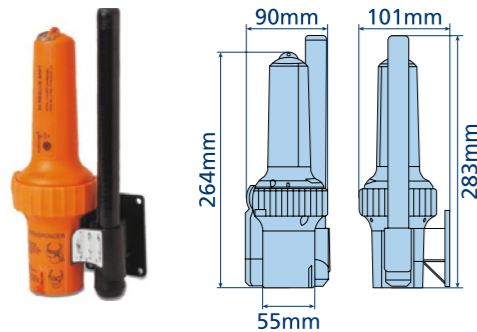

- Search & Rescue Transponder
- 9GHz X-band Radar transceiver
- Designed for assisting air/sea ship or survival craft rescue operations in accordance with IMO, GMDSS requirements
- Extremely simple to use, compact, lightweight, buoyant
- Can be operated even with gloved or wet hands
- Audio/visual indication of operation
- Built-in test facility
- Integral lanyard
- Mounting options – internal/external
- Replaceable, 5 year battery pack
- Waterproof up to 10 metres
- Standby mode duration: over 96 hours
- Operating temperature: -20° C to +55°C
- Storage temperature: -30°C to +65°C

**Weight:**  
 360g (without mast or bracket)  
 510g (with mast)  
 530g (with mast & bracket)

**Dimensions:** L.264mm x D.90mm

Code: MM MCM 86300004

### mcmurdo

#### SMARTFIND 55 AIS SART



- Automatic Identification System Search & Rescue Transmitter
- Internationally approved
- Intended for use on life rafts or survival craft
- It meets IMO SOLAS requirements; alternative to a Radar SART
- Built-in high precision GPS
- Easy to operate, rugged, compact, lightweight, buoyant
- Visual indication of operation
- Built-in test facility
- Integral lanyard
- 96 hour operational battery life (6-year life)
- Mounting options – internal/external
- Waterproof up to 10 metres
- Operating temperature: -20° C to +55°C
- Storage temperature: -30°C to +70°C
- Comes complete in its own carry case

**Weight:**  
 10g (main unit)  
 450g (including pole)  
 940g (packed)

**Dimensions:**  
 H.330mm x W.85mm (main unit)  
 155 cm LOA including pole  
 H.390mm x D.80mm x W.150mm (packed)

Code: MM MCM 92-001-001A



#### PATHFINDER 3 SART

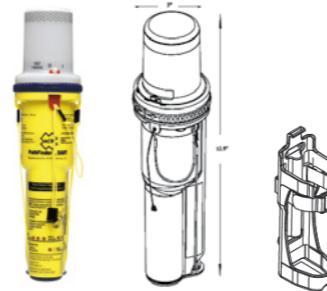

Code: MM ACR 2714NH

- Search & Rescue Transponder
- Complies with GMDSS, IMO/SOLAS standards
- Unit transmits through the 9.2-9.5 GHz band marine radar when interrogated by radar
- Compact unit easily packs into liferaft
- Visual/audible feedback confirming operational status
- Quick release mounting bracket included
- 1mt collapsible pole stowed inside case
- 10mt (33ft) lanyard
- Standby mode duration: 96 hours
- High impact polystyrene case
- Hi-Viz yellow
- Deployment: manual
- Battery: lithium, 5-year replacement life
- Waterproof up to 10 metres
- Weight: 680g (24 oz)
- Dimensions: H.31.8 cm x W.7.6 cm (12.5" x 3")



#### SEASAFE S100 SART



Code: MM OCG S100

- SafeSea S100 Search and Rescue Transponder
- Superior battery life - even at -20°C
- User replaceable battery
- Non Hazardous battery
- 5 year replacement interval
- Compact size for easy liferaft packing
- Supplied complete with telescopic pole and storage bracket

Frequency range	9.2-9.5GHz
Radiated output power	>26dBm eirp
Operating Temperature Range	-20°C to +55°C
Storage Temperature Range	-30°C to +70°C
Waterproof	>10metres at +20°C
Height	227mm
Body Diameter (max)	65mm (82mm)

## SARTs specifications sheets, products manuals, Certificates of approvals available on request.

For your telephone orders ..... +39 0184 573346 press #1

E-mail orders and estimates ..... sales@mansuetomarine.it

Technical support ..... technical@mansuetomarine.it

Product Support & Data-Sheets ..... service@mansuetomarine.it

General Inquiries ..... info@mansuetomarine.it



## EPIRB

## mcmurdo

## SMARTFIND/E5 406 MHz EPIRB (MANUAL BRACKET) - STANDARD VERSION\*



- Internationally Approved
- Transmits on 406 and 121.5MHz
- Non hazardous battery for safe and easy transportation
- Unique CARRYSAFE bracket available for safe transportation
- High brightness LED flashing locator light
- 60 comprehensive diagnostic and self-tests during battery life
- Once activated, will transmit for a minimum of 48 hours
- 5 year battery life
- 5 year warranty
- Once removed from its CARRYSAFE manual bracket the unit can be activated automatically by immersion in water or manually by following the activation instructions on the unit.

Code: MM MCM E5MB

\*PLUS version also available: SMARTFIND PLUS/G5 406 MHz EPIRB (MANUAL BRACKET)

Same advanced features of standard Smartfind/E5 + built-in GPS receiver.  
Hi performance multi-channel integral GPS giving a typical location accuracy of less than +/- 62 m.  
GPS uses an array of 27 satellites and provides continuous positional information with a typical accuracy of around 30m.

Code: MM MCM G5MB

## mcmurdo

## SMARTFIND/E5 406 MHz EPIRB (AUTO FLOAT FREE HOUSING) - STANDARD VERSION\*

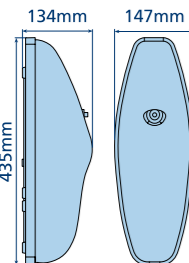

- Internationally Approved
- Transmits on 406 and 121.5MHz
- High performance multi-channel integral GPS giving a typical location accuracy of less than +/- 62 m (Plus version)
- Non hazardous battery for safe and easy transportation
- Unique CARRYSAFE bracket available for safe transportation
- High brightness LED flashing locator light
- 60 comprehensive diagnostic and self-tests during battery life
- Once activated, will transmit for a minimum of 48 hours
- 5 year battery life
- 5 year warranty
- The Auto Float Free Housing will automatically deploy the EPIRB when submerged to a depth lower than 2 - 4metres in the sea.

Code: MM MCM E5AFFH

\*PLUS version also available: SMARTFIND PLUS/G5 GPS EPIRB (AUTO FLOAT FREE HOUSING)

Same advanced features of standard Smartfind/E5 with Auto Float Free Housing + built-in GPS receiver.  
Hi performance 12-channel integral GPS giving a typical location accuracy of less than +/- 62 m for enhanced position location.

Code: MM MCM G5AFFH

MANSUETO MARINE



## TRON 40S MKII - FLOAT FREE GMDSS EPIRB



- Battery: Lithium metal, 7,2V/7200 mAh, 5 years service life
- Materials: Glass-reinforced Polycarbonate
- Compass safe distance: 1.5m
- Temperature range: -20°C to + 55°C (operating) -30°C to +65°C (storage)
- Operating life: Minimum 48 hours at -20°C
- Antenna: Omni directional
- Cospas-Sarsat Transmitter: Frequency: 406.037 MHz Output power: 5W
- Homing transmitter: Frequency: 121.500 MHz Output power: Up to 100 mW
- Protocols: Maritime, Serialized, Radio Call sign
- Nav. device: 12 Channel GPS Receiver (Tron 40GPS mkII)

- Accessories:**
- Brackets: Float-free: FB-6
  - Float-free with heating: FBH-4
  - Battery: Replacement kit
  - Hydrostatic release: HRU kit

- Dimensions:**
- Height: 379 mm
  - Diameter: 180mm

- Weight: 2 Kg
- Warranty: 5 years

Code: MM JOR 83050 (complete main unit)



## TRON 60S - FLOAT FREE GMDSS EPIRB



- Battery: Lithium metal, 12V/2900 mAh, 5 years service life
- Materials: Glass reinforced Polycarbonate
- Compass safe distance: 1 m
- Temperature range: Operating: -20°C to + 55°C Storage: -30°C to +65°C
- Operating life: Minimum 48 hours at -20°C
- Antenna: Omnidirectional
- Cospas-Sarsat Transmitter: Frequency: 406.037 MHz Output power: 5W
- Homing transmitter: Frequency: 121.500 MHz Output power: Up to 100 mW
- Protocols: Maritime, Serialized, Radio Call sign
- Navigation device: 22 Channel GPS Receiver (Tron 60GPS)

- Accessories:**
- Brackets: Float-free: FB-60
  - Manual: MB-60
  - Battery: Replacement kit
  - Hydrostatic release: HRU kit

- Dimensions:**
- Height: 340 mm
  - Diameter: 128mm

- Weight: 680 g
- Warranty: 5 years

Code: MM JOR 83310 (W/Float-free bracket)



## GLOBALFIX™ IPRO 406 MHz GPS EPIRB CAT I\*



- Model RLB-36
- Category I – Hydrostatic release (auto)
- Transmits on 406 MHz and 121.5 MHz
- Digital display
- Dual GPS technology: internal 66 channels; external GPS connection
- 5 Year Non hazardous lithium batteries
- Professional grade design, ergonomic, compact
- High impact UV resistant polymer

- Highly visible LED strobe – Energy efficient
- Self-test results
- Operational life: 48 hours minimum at -20°C
- 5 year warranty

- Accessories:**
- Automatic Category I Sea Shelter™3 bracket (P/N 9501) is fully enclosed; made of high density, UV-stabilized polyethylene
  - Cat I HydroFix™ HRU (P/N 9490)

Code: MM ACR 2846.0

\*Cat II also available: GlobalFix™ iPRO 406 MHz GPS EPIRB CAT II



Same advanced features of GlobalFix™ iPRO 406 MHz GPS EPIRB Cat I but manual release.  
Accessory: Manual Category II LowPro™3 (P/N 9502). Low profile; 2-part design for easy mounting and quick removal when needed.

Code: MM ACR 2848.0

www.mansuetomarine.it





**SATELLITE 3 406™ 406 MHZ CAT I\***



- Model RLB-38
- Category I – Hydrostatic release (auto)
- Transmits on 406 MHz and 121.5 MHz
- Upgrade to GPS positioning with the optional GPS interface cable (sold separately)
- This connects the Satellite 3 406™ to your vessel's GPS receiver
- Non hazardous lithium batteries
- Professional grade design, ergonomic, compact
- High impact UV resistant polymer
- Highly visible LED strobe – Energy efficient
- Audio/visual indicators – Shows active transmission
- Full functional self-test
- Single, 3-position switch for easy test and operation
- Operational life: 48 hours minimum @ -20°C
- 5 year battery life
- 5 year warranty

**Accessories:**

- Automatic Category I Sea Shelter™3 bracket (P/N 9501)
- Cat I HydroFix™ HRU (P/N 9490)
- Optical GPS Interface Cable Cat I (P/N 9388.1)

Code: MM ACR 2874

\*Cat II also available: **Satellite 3 406™ 406 MHZ CAT II**

Same advanced features of Satellite 3 406™ 406 MHZ CAT I but manual release.

**Accessories:**

- Manual Category II QuickDraw™ (P/N 9507). Low profile; easy to rail mount or secure on deck.
- Optical GPS Interface Cable Cat II (P/N 9388)

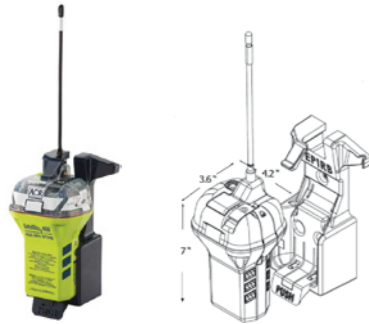

Code: MM ACR 2875

**HAMMAR®**

**HYDROSTATIC RELEASE UNIT FOR EPIRBs – H20E**



- Should the vessel sink, the Hammar H20, which is activated by increasing water pressure, will automatically release the EPIRB.
- Made of glassfibre reinforced nylon
- Use only manufacturer approved replacement bolt (rod)
- Bolt securing the EPIRB will be cut when the release unit is activated.
- It needs no annual service, maintenance or spare parts
- Simply replace it every 2 years together with its bolt
- Meets SOLAS requirements/ USCG approved

Code: MM HMM H20E

**mcmurdo**

**BREAKTHRU HYDROSTATIC RELEASE UNIT FOR EPIRB**



- Smaller than other HRUs currently available
- Used to enable EPIRBs to automatically float free
- The pyrotechnic charge is used to activate the HRU when it is submerged in water < 13 feet
- Complies with SOLAS and IMO regulations

Code: MM MCM 82962001A

**Our Safety Department can take care of your old SARTs, EPIRBs and HRUs disposal service.**



**LIFERAFTS**



**RFD SURVIVA - SOLAS APPROVED LIFERAFTS**

**FRONT VIEW**

**BACK VIEW**

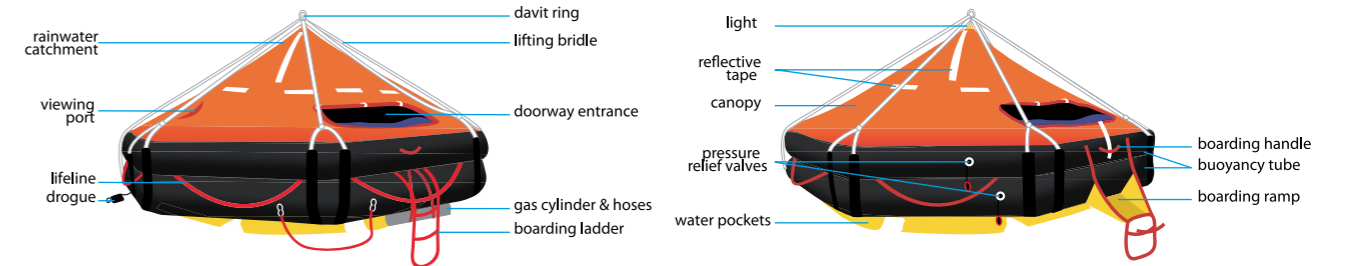

Liferafts are stowed in a glass reinforced plastic (GRP) container. Surviva range includes two different models:

- standard throw-over liferafts
- davit-launched liferafts

**HOW TO ORDER YOUR RFD LIFERAFT:**

**MM + RFD + CAPACITY + SOLAS A or B**



**MK10 CYLINDRICAL CONTAINER**

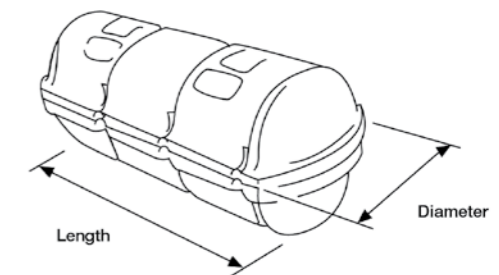

SOLAS A PACK			
Rated Capacity	Length mm	Diameter mm	Weight Kg
6	1260	485	76
8	1260	485	80
10	1385	535	100
12	1385	535	109
16	1530	530	137
20	1635	585	158
25	1635	585	178
12 DL	1385	535	114
16 DL	1530	530	139
20 DL	1635	585	160
25 DL	1635	585	183

SOLAS B PACK			
Rated Capacity	Length mm	Diameter mm	Weight Kg
6	1160	435	57
8	1160	435	57
10	1260	485	80
12	1260	485	85
16	1390	535	103
20	1540	530	109
25	1540	530	128
12 DL	1260	435	90
16 DL	1390	535	107
20 DL	1540	530	120
25 DL	1540	530	133



**MK14 CYLINDRICAL CONTAINER**

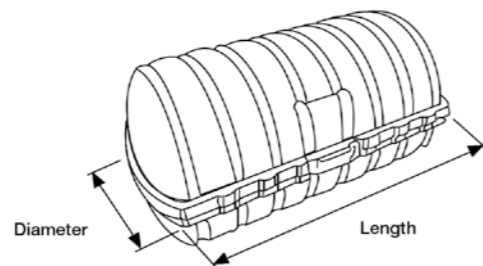

SOLAS A PACK			
Rated Capacity	Length mm	Diameter mm	Weight Kg
6	1066	556	76
10	1156	584	99
12	1156	584	106
16	1308	685	144
20	1308	685	160
25	1308	685	180
12 DL	1156	584	113
16 DL	-	-	-
20 DL	1308	685	163
25 DL	1308	685	185

SOLAS B PACK			
Rated Capacity	Length mm	Diameter mm	Weight Kg
6	1066	556	57
10	-	-	-
12	1156	584	79
16	1156	584	101
20	1156	584	106
25	1308	685	130
12 DL	1156	584	92
16 DL	1156	584	106
20 DL	1308	685	123
25 DL	1308	685	135



**FLAT PACK CONTAINER**

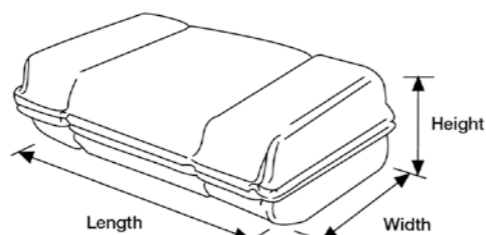

SOLAS A PACK				
Rated Capacity	Length mm	Width mm	Height mm	Weight Kg
6	985	670	435	76
8	985	670	435	86
10	1190	650	315	101
12	1190	650	315	110
20 DL	1525	829	505	160
25 DL	1525	820	505	183

SOLAS B PACK				
Rated Capacity	Length mm	Width mm	Height mm	Weight Kg
6	900	646	310	57
8	985	670	435	62
10	1190	650	315	85
12	1190	650	315	90
20 DL	-	-	-	-
25 DL	1525	820	505	153

**Contact our Sales Department at [sales@mansuetomarine.it](mailto:sales@mansuetomarine.it) to get our best quote for your new liferafts**



**ROUND CONTAINER 6 MAN THROW OVER BOARD LIFERAFT SOLAS A & B PACK**

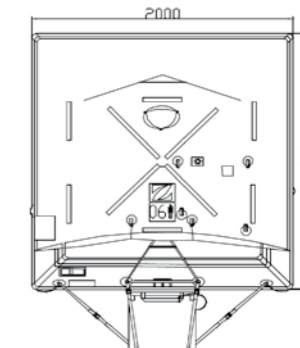
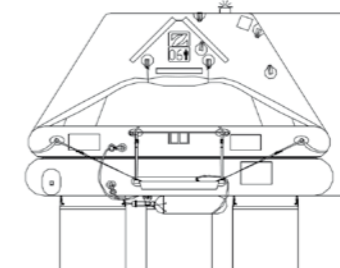

Code: MM ZOD 6PCYL (A or B)

	SOLAS A PACK	SOLAS B PACK
Container	N12	N11
Dimensions	X: 1160 mm Y: 560 mm Z: 513 mm X: 3' 9,67" Y: 1' 10,05" Z: 1' 8,2"	X: 1020 mm Y: 476 mm Z: 440 mm X: 3' 4,16" Y: 1' 6,75" Z: 1' 5,33"
Liferaft Net Weight	68 kg / 150 pounds	52 kg / 115 pounds
Height stowage	25 m / 83' 36 m / 119'	25 m / 83' 36 m / 119'
Painter line length	35 m / 115' 50 m / 165'	35 m / 115' 50 m / 165'
Inflation Cylinder	1 x 4 liter	
APPROVALS:	EC (MED) – USCG – TC – RMRS – BV – CCS	



**ROUND CONTAINER 8 MAN THROW OVER BOARD LIFERAFT SOLAS A & B PACK**

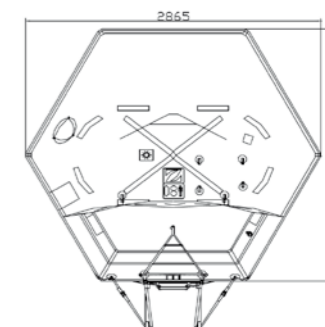
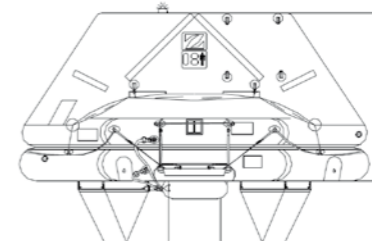

Code: MM ZOD 8PCYL (A or B)

	SOLAS A PACK	SOLAS B PACK
Container	N12	N12
Dimensions	X: 1160 mm Y: 560 mm Z: 513 mm X: 3' 9,67" Y: 1' 10,05" Z: 1' 8,2"	X: 1160 mm Y: 560 mm Z: 513 mm X: 3' 9,67" Y: 1' 10,05" Z: 1' 8,2"
Liferaft Net Weight	77 kg / 170 pounds	58 kg / 128 pounds
Height stowage	25 m / 83' 36 m / 119'	25 m / 83' 36 m / 119'
Painter line length	35 m / 115' 50 m / 165'	35 m / 115' 50 m / 165'
Inflation Cylinder	1 x 6,7 liter	
APPROVALS:	EC (MED) – USCG – TC – RMRS – BV – CCS	



**ROUND CONTAINER 10 MAN THROW OVER BOARD LIFERAFT SOLAS A & B PACK**

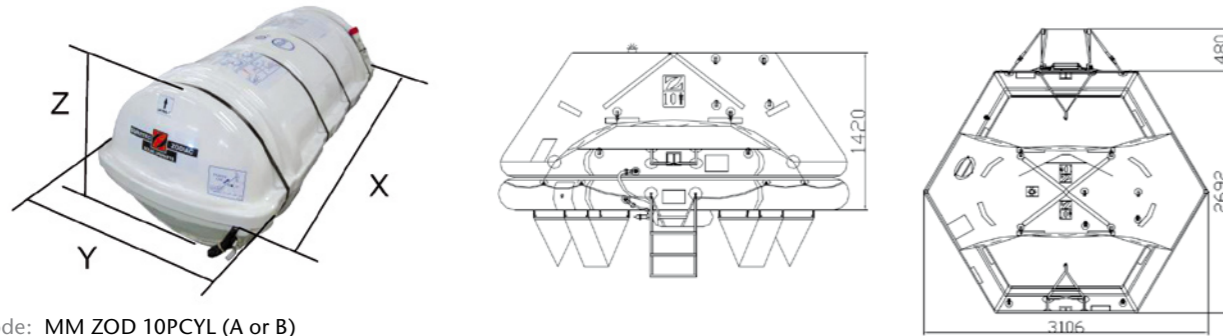

Code: MM ZOD 10PCYL (A or B)

	SOLAS A PACK	SOLAS B PACK
Container	N13	N12
Dimensions	X: 1275 mm Y: 610 mm Z: 590 mm X: 4' 2,2" Y: 2' 0,02" Z: 1' 11,23"	X: 1160 mm Y: 560 mm Z: 513 mm X: 3' 9,67" Y: 1' 10,05" Z: 1' 8,2"
Liferaft Net Weight	92 kg / 203 pounds	63 kg / 139 pounds
Height stowage	25 m / 83' 36 m / 119'	25 m / 83' 36 m / 119'
Painter line length	35 m / 115' 50 m / 165'	35 m / 115' 50 m / 165'
Inflation Cylinder	1 x 6,7 liter	
APPROVALS:	EC (MED) – USCG – TC – RMRS – BV – CCS	



**ROUND CONTAINER 12 MAN THROW OVER BOARD LIFERAFT (NG) SOLAS A & B PACK**

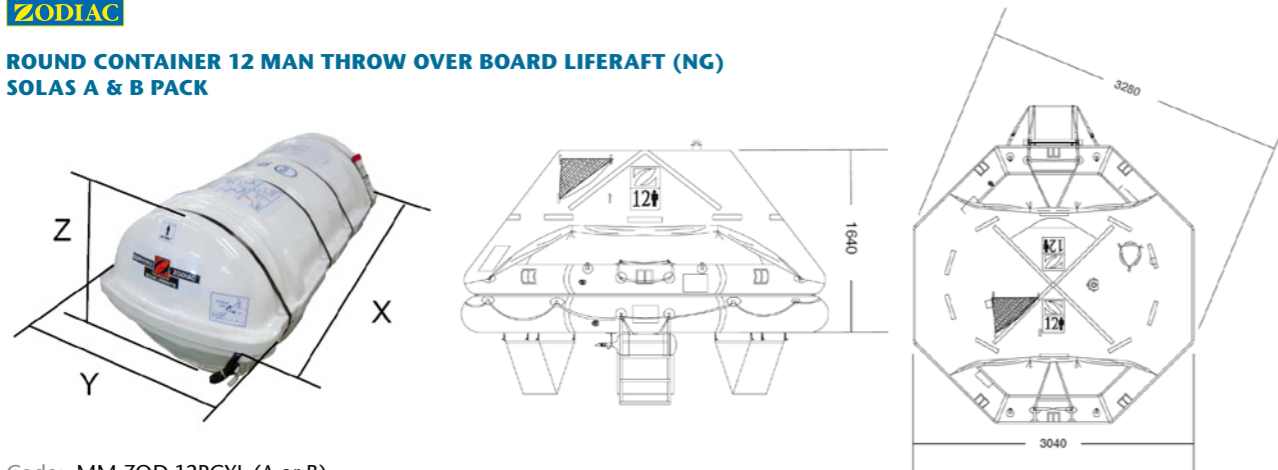

Code: MM ZOD 12PCYL (A or B)

	SOLAS A PACK	SOLAS B PACK
Container	N13	N12
Dimensions	X: 1275 mm Y: 610 mm Z: 590 mm X: 4' 2,2" Y: 2' 0,02" Z: 1' 11,23"	X: 1160 mm Y: 560 mm Z: 513 mm X: 3' 9,67" Y: 1' 10,05" Z: 1' 8,2"
Liferaft Net Weight	101 kg / 223 pounds	70 kg / 155 pounds
Max Height stowage	36 m / 119'	25 m / 83'
Painter line length	50 m / 165'	35 m / 115'
Inflation Cylinder	1 x 8 liter	
APPROVALS:	EC (MED) – USCG – TC – RMRS – BV	



**ROUND CONTAINER 16 MAN THROW OVER BOARD LIFERAFT SOLAS A & B PACK**

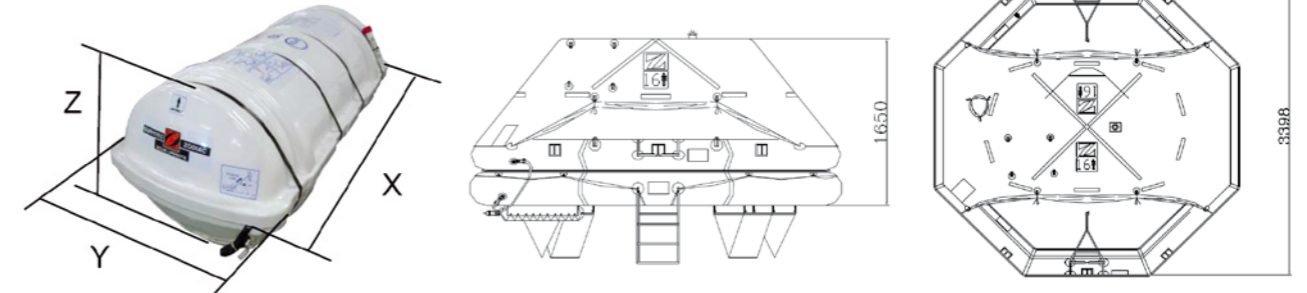

Code: MM ZOD 16PCYL (A or B)

	SOLAS A PACK	SOLAS B PACK
Container	N14	N13
Dimensions	X: 1275 mm Y: 680 mm Z: 615 mm X: 4' 2,2" Y: 2' 2,78" Z: 2' 0,22"	X: 1275 mm Y: 610 mm Z: 590 mm X: 4' 2,2" Y: 2' 0,02" Z: 1' 11,23"
Liferaft Net Weight	129 kg / 285 pounds	91 kg / 201 pounds
Height stowage	25 m / 83' 36 m / 119'	25 m / 83' 36 m / 119'
Painter line length	35 m / 115' 50 m / 165'	35 m / 115' 50 m / 165'
Inflation Cylinder	1 x 15 liter	
APPROVALS:	EC (MED) – USCG – TC – RMRS – BV – CCS	



**ROUND CONTAINER 20 MAN THROW OVER BOARD LIFERAFT SOLAS A & B PACK**

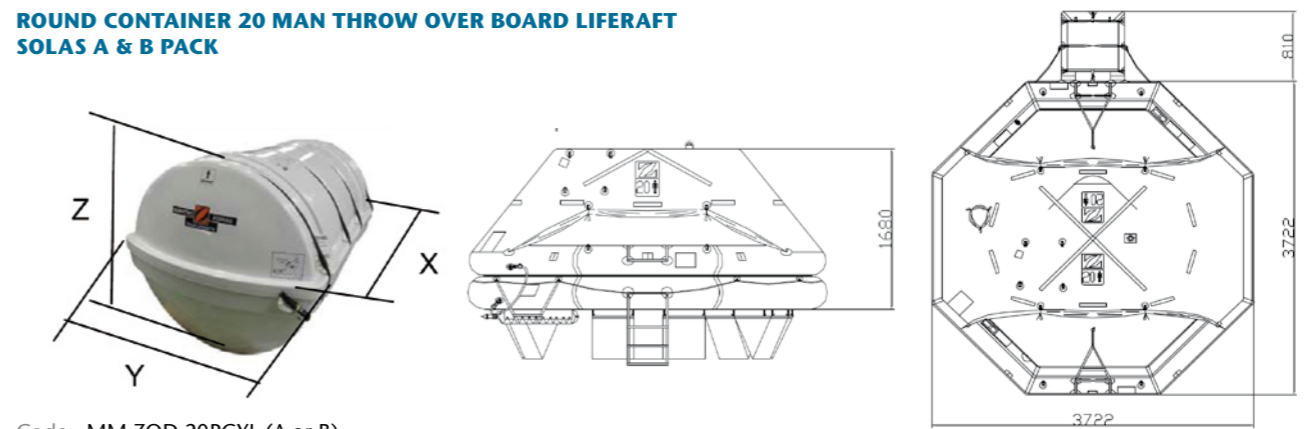

Code: MM ZOD 20PCYL (A or B)

	SOLAS A PACK	SOLAS B PACK
Container	N15	N13
Dimensions	X: 1275 mm Y: 800 mm Z: 740 mm X: 4' 2,2" Y: 2' 7,5" Z: 2' 5,14"	X: 1275 mm Y: 610 mm Z: 590 mm X: 4' 2,2" Y: 2' 0,02" Z: 1' 11,23"
Liferaft Net Weight	150 kg / 331 pounds	92 kg / 203 pounds
Height stowage	25 m / 83' 36 m / 119'	25 m / 83' 36 m / 119'
Painter line length	35 m / 115' 50 m / 165'	35 m / 115' 50 m / 165'
Inflation Cylinder	1 x 15 liter	
APPROVALS:	EC (MED) – USCG – TC – RMRS – BV – CCS	





**ROUND CONTAINER 25 MAN THROW OVER BOARD LIFERAFT SOLAS A & B PACK**

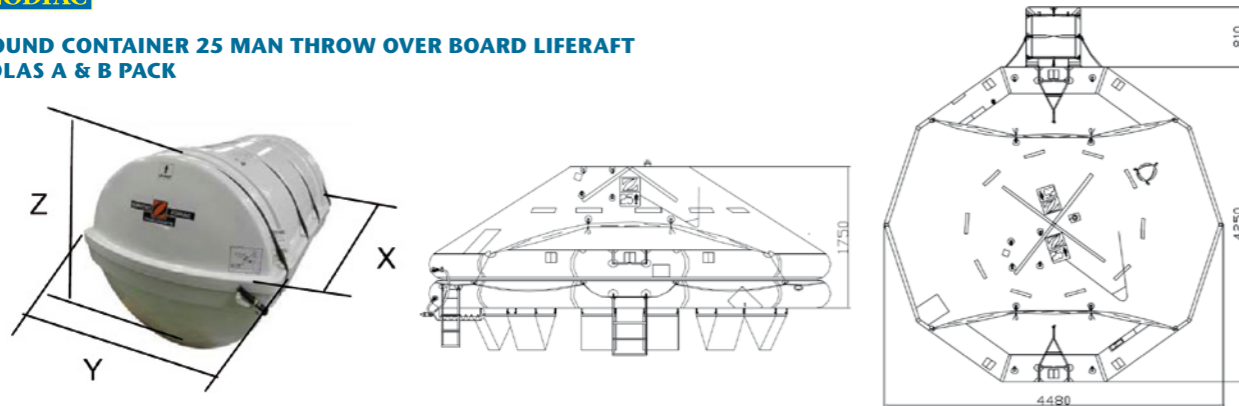

Code: MM ZOD 25PCYL (A or B)

	SOLAS A PACK	SOLAS B PACK
Container	N15GM	N14
Dimensions	X: 1275 mm Y: 800 mm Z: 755 mm X: 4' 2,2" Y: 2' 7,5" Z: 2' 5,73"	X: 1275 mm Y: 680 mm Z: 615 mm X: 4' 2,2" Y: 2' 2,78" Z: 2' 0,22"
Liferaft Net Weight	173 kg / 382 pounds	113 kg / 250 pounds
Height stowage	25 m / 83' 36 m / 119'	25 m / 83' 36 m / 119'
Painter line length	35 m / 115' 50 m / 165'	35 m / 115' 50 m / 165'
Inflation Cylinder	1 x 20 liter	
APPROVALS:	EC (MED) – USCG – TC – RMRS – BV – CCS	



**ROUND CONTAINER 50 MAN THROW OVER BOARD LIFERAFT SOLAS A & B PACK**

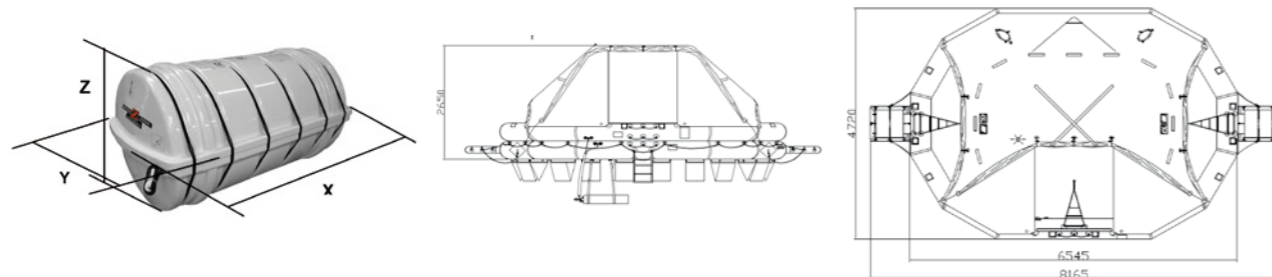

Code: MM ZOD 50PCYL (A or B)

	SOLAS A PACK	SOLAS B PACK
Container	N20	N18
Dimensions	X: 1560 mm Y: 952 mm Z: 960 mm X: 5' 1,42" Y: 3' 1,49" Z: 3' 1,8"	X: 1560 mm Y: 852 mm Z: 835 mm X: 5' 1,42" Y: 2' 9,55" Z: 2' 8,88"
Liferaft Net Weight	369 kg / 814 pounds	233 kg / 514 pounds
Max Height stowage	20 m / 66'	20 m / 66'
Painter line length	30 m / 99'	
Inflation Cylinder	2 x 27 liter	
APPROVALS:	EC (MED) – USCG – TC – BV	



**4 MAN THROW OVER BOARD LIFERAFT LOW PROFILE CONTAINER A & B PACK**

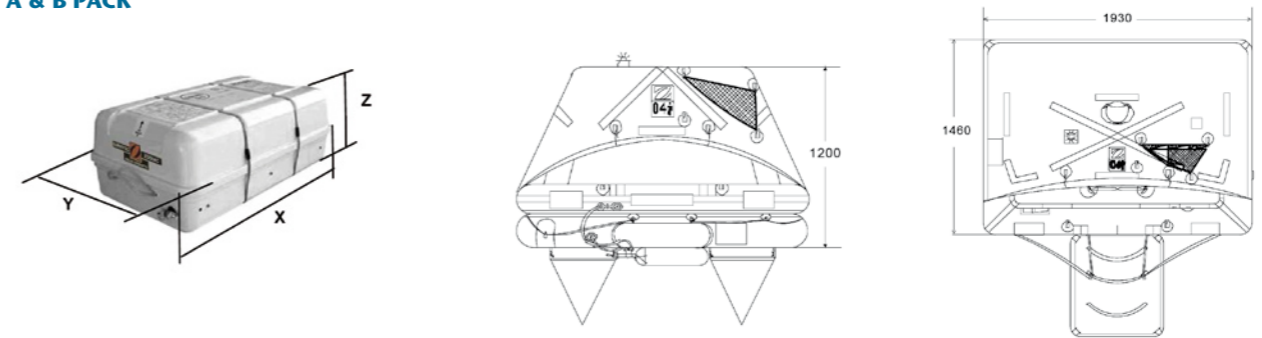

Code: MM ZOD 4PFLAT (A or B)

	SOLAS A PACK	SOLAS B PACK
Container	N133	N133
Dimensions	X: 924 mm Y: 574 mm Z: 359 mm X: 3' 0,38" Y: 1' 10,6" Z: 1' 2,14"	X: 924 mm Y: 574 mm Z: 359 mm X: 3' 0,38" Y: 1' 10,6" Z: 1' 2,14"
Liferaft Net Weight	57 kg / 126 pounds	46 kg / 102 pounds
Max Height stowage	20 m / 66'	20 m / 66'
Painter line length	30 m / 99'	
Inflation Cylinder	1 x 4 liter	
APPROVALS:	USCG - TC	



**LOW PROFILE CONTAINER 6 MAN THROW OVER BOARD LIFERAFT SOLAS A & B PACK**

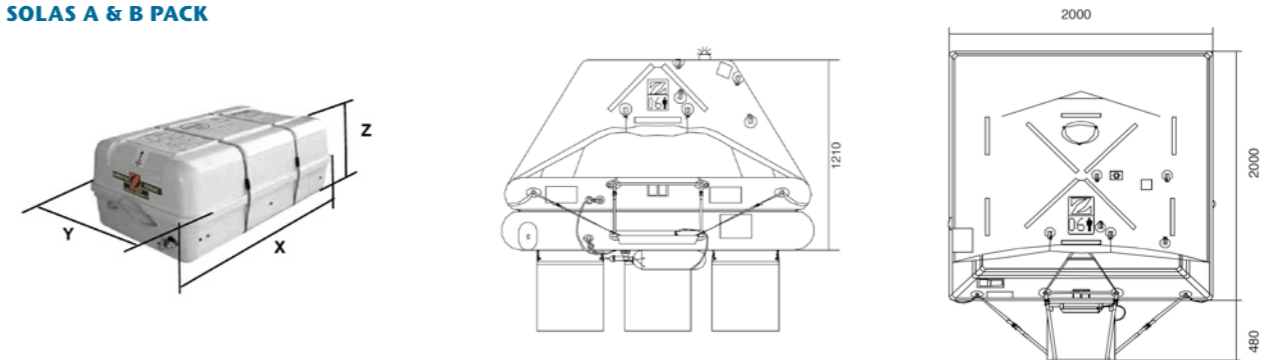

Code: MM ZOD 6PFLAT (A or B)

	SOLAS A PACK	SOLAS B PACK
Container	N134	N133
Dimensions	X: 965 mm Y: 596 mm Z: 380 mm X: 3' 2" Y: 1' 11,47" Z: 1' 2,97"	X: 924 mm Y: 574 mm Z: 359 mm X: 3' 0,38" Y: 1' 10,6" Z: 1' 2,14"
Liferaft Net Weight	66 kg / 146 pounds	51 kg / 113 pounds
Max Height stowage	18 m / 60'	18 m / 60'
Painter line length	30 m / 99'	
Inflation Cylinder	1 x 4 liter	
APPROVALS:	EC (MED) – USCG – TC – BV – CCS	



**LOW PROFILE CONTAINER 8 MAN THROW OVER BOARD LIFERAFT SOLAS A & B PACK**

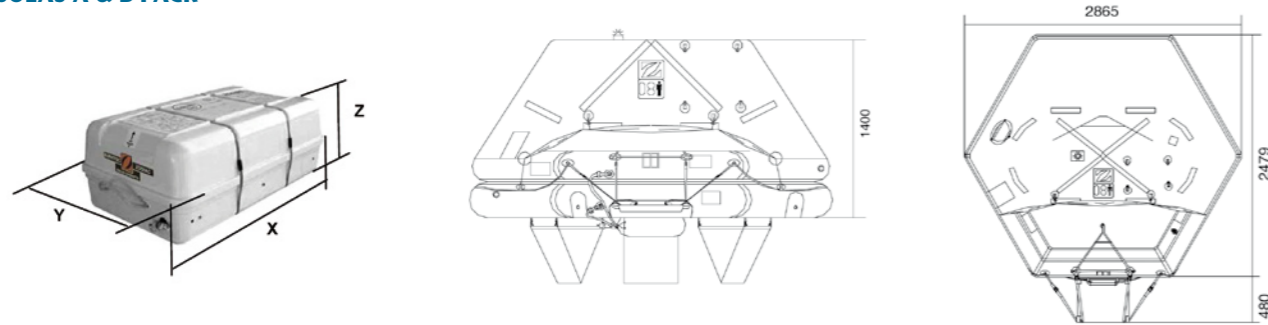

Code: MM ZOD 8PFLAT (A or B)

	SOLAS A PACK	SOLAS B PACK
Container	N135	N134
Dimensions	X: 1088 mm Y: 666 mm Z: 389 mm X: 3' 6,84" Y: 2' 2,23" Z: 1' 3,32"	X: 965 mm Y: 596 mm Z: 380 mm X: 3' 2" Y: 1' 11,47" Z: 1' 2,97"
Liferaft Net Weight	79 kg / 175 pounds	57 kg / 126 pounds
Max Height stowage	25 m / 83'	25 m / 83'
Painter line length	35 m / 115'	
Inflation Cylinder	1 x 6,7 liter	
APPROVALS:	EC (MED) – BV – CCS	



**LOW PROFILE CONTAINER 10 MAN THROW OVER BOARD LIFERAFT SOLAS A & B PACK**

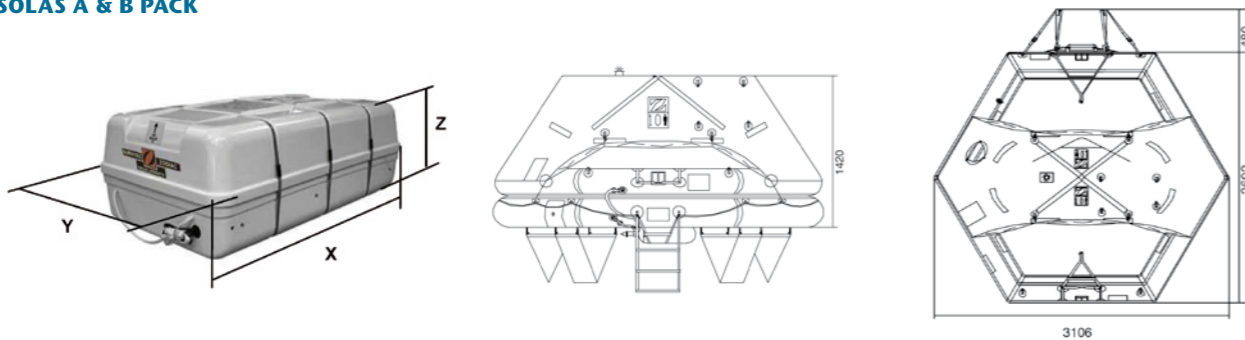

Code: MM ZOD 10PFLAT (A or B)

	SOLAS A PACK	SOLAS B PACK
Container	N135	N135
Dimensions	X: 1088 mm Y: 666 mm Z: 389 mm X: 3' 6,84" Y: 2' 2,23" Z: 1' 3,32"	X: 1088 mm Y: 666 mm Z: 389 mm X: 3' 6,84" Y: 2' 2,23" Z: 1' 3,32"
Liferaft Net Weight	90 kg / 199 pounds	65 kg / 144 pounds
Max Height stowage	18 m / 60'	18 m / 60'
Painter line length	30 m / 99'	
Inflation Cylinder	1 x 6,7 liter	
APPROVALS:	EC (MED) – USCG – TC – BV – CCS	



**LOW PROFILE CONTAINER 12 MAN THROW OVER BOARD LIFERAFT (NG) SOLAS A & B PACK**

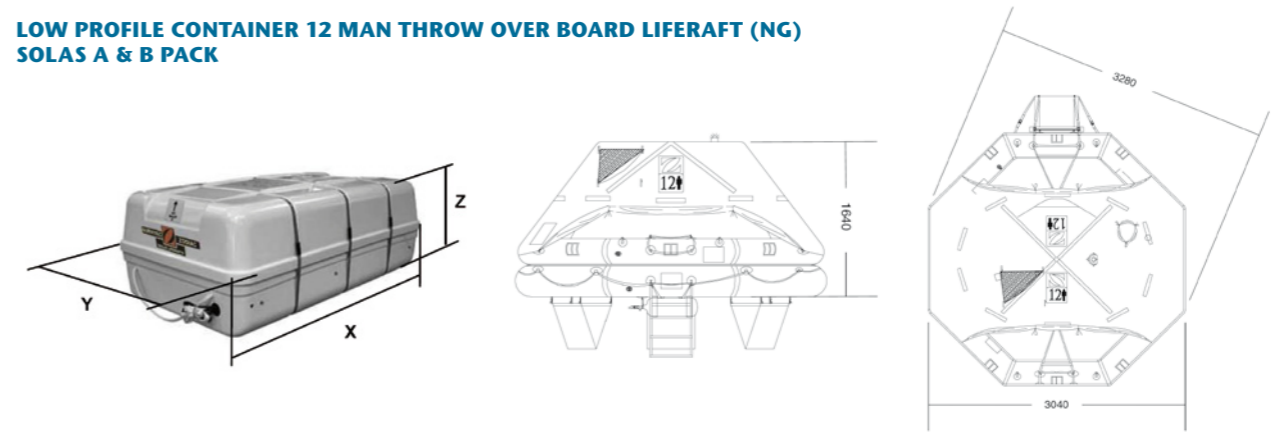

Code: MM ZOD 12PFLAT (A or B)

	SOLAS A PACK	SOLAS B PACK
Container	N135	N134
Dimensions	X: 1088 mm Y: 666 mm Z: 389 mm X: 3' 6,84" Y: 2' 2,23" Z: 1' 3,32"	X: 965 mm Y: 596 mm Z: 380 mm X: 3' 2" Y: 1' 11,47" Z: 1' 2,97"
Liferaft Net Weight	100 kg / 221 pounds	69 kg / 153 pounds
Max Height stowage	18 m / 60'	18 m / 60'
Painter line length	30 m / 99'	
Inflation Cylinder	1 x 8 liter	
APPROVALS:	EC (MED) – USCG – TC – BV	



**LOW PROFILE CONTAINER 16 MAN THROW OVER BOARD LIFERAFT SOLAS A & B PACK**

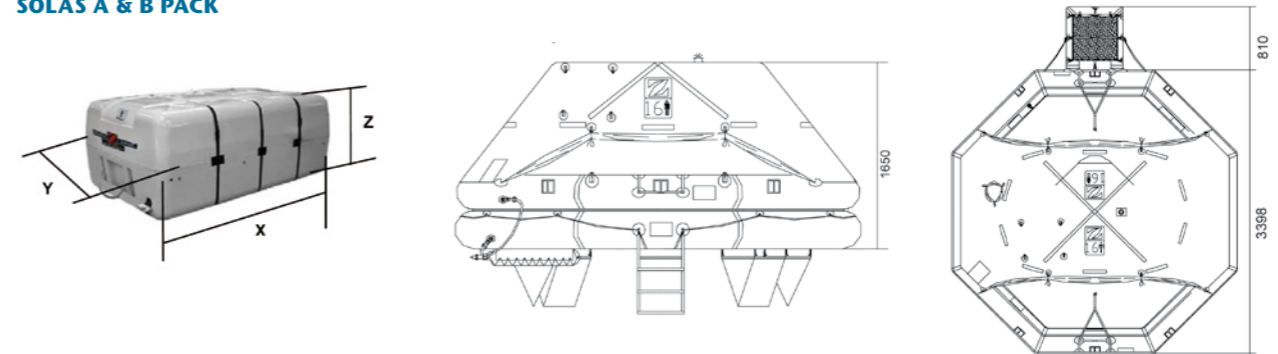

Code: MM ZOD 16PFLAT (A or B)

	SOLAS A PACK	SOLAS B PACK
Container	N136H	N136
Dimensions	X: 1160 mm Y: 730 mm Z: 468 mm X: 3' 9,67" Y: 2' 4,75" Z: 1' 6,43"	X: 1160 mm Y: 730 mm Z: 408 mm X: 3' 9,67" Y: 2' 4,75" Z: 1' 4,07"
Liferaft Net Weight	126 kg / 278 pounds	87 kg / 192 pounds
Max Height stowage	18 m / 60'	18 m / 60'
Painter line length	30 m / 99'	
Inflation Cylinder	1 x 15 liter	
APPROVALS:	EC (MED) – USCG – TC – BV – CCS	



**LOW PROFILE CONTAINER 20 MAN THROW OVER BOARD LIFERAFT SOLAS A & B PACK**

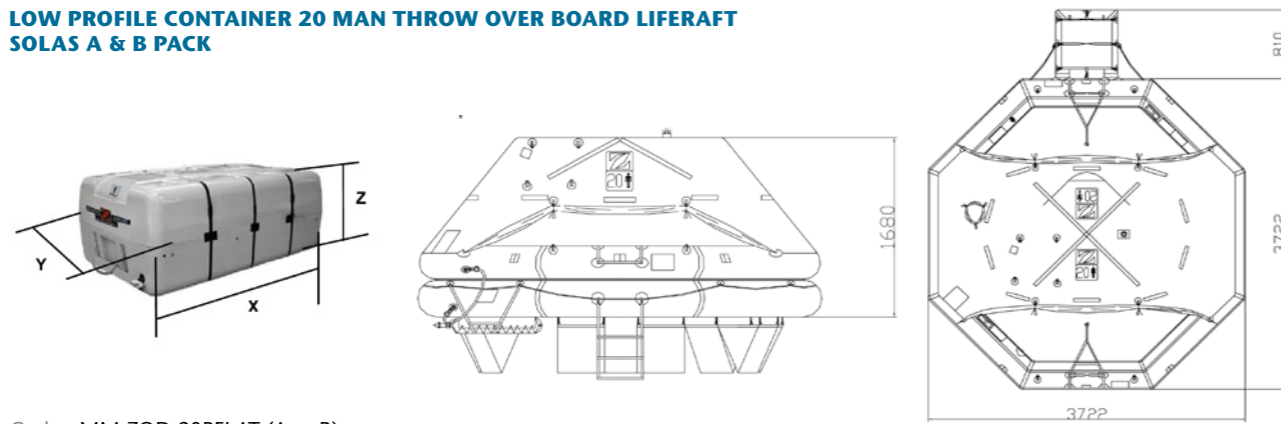

Code: MM ZOD 20PFLAT (A or B)

	SOLAS A PACK	SOLAS B PACK
Container	N136H	N136
Dimensions	X: 1160 mm Y: 730 mm Z: 468 mm X: 3' 9,67" Y: 2' 4,75" Z: 1' 6,43"	X: 1160 mm Y: 730 mm Z: 408 mm X: 3' 9,67" Y: 2' 4,75" Z: 1' 4,07"
Liferaft Net Weight	144 kg / 318 pounds	95,5 kg / 211 pounds
Max Height stowage	18 m / 60'	18 m / 60'
Painter line length	30 m / 99'	
Inflation Cylinder	1 x 15 liter	
APPROVALS:	EC (MED) – BV – TC – USCG – CCS	



**XTREM – LOW PROFILE CONTAINER 6 MAN THROW OVER BOARD LIFERAFT SOLAS A & B PACK**

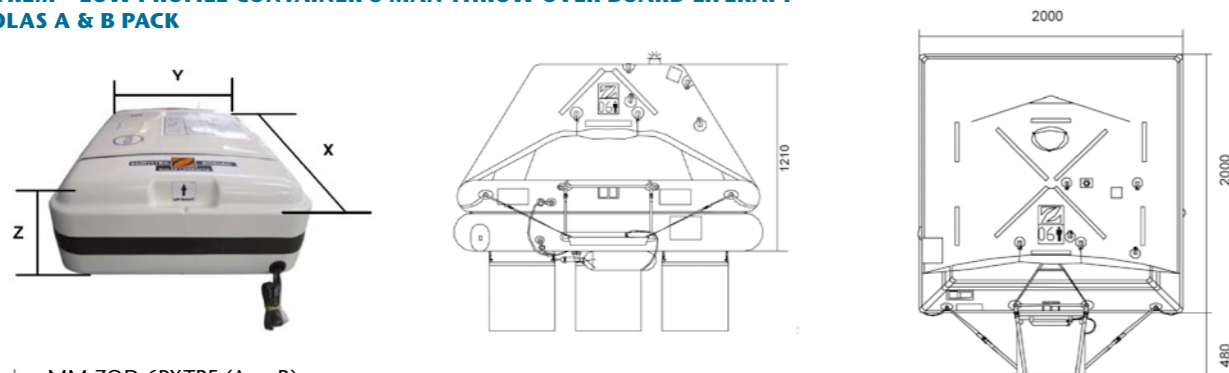

Code: MM ZOD 6PXTRE (A or B)

	SOLAS A PACK	SOLAS B PACK
Container	N137H	N137
Dimensions	X: 790 mm Y: 555 mm Z: 340 mm X: 2' 7,11" Y: 1' 9,86" Z: 1' 1,39"	X: 790 mm Y: 555 mm Z: 270 mm X: 2' 7,11" Y: 1' 9,86" Z: 10,63"
Liferaft Net Weight	64 kg / 142 pounds	48 kg / 106 pounds
Max Height stowage	18 m / 60'	18 m / 60'
Painter line length	30 m / 99'	
Inflation Cylinder	1 x 4 liter	
APPROVALS:	EC (MED) – USCG – TC – BV – CCS	



**XTREM – LOW PROFILE CONTAINER 8 MAN THROW OVER BOARD LIFERAFT SOLAS A & B PACK**

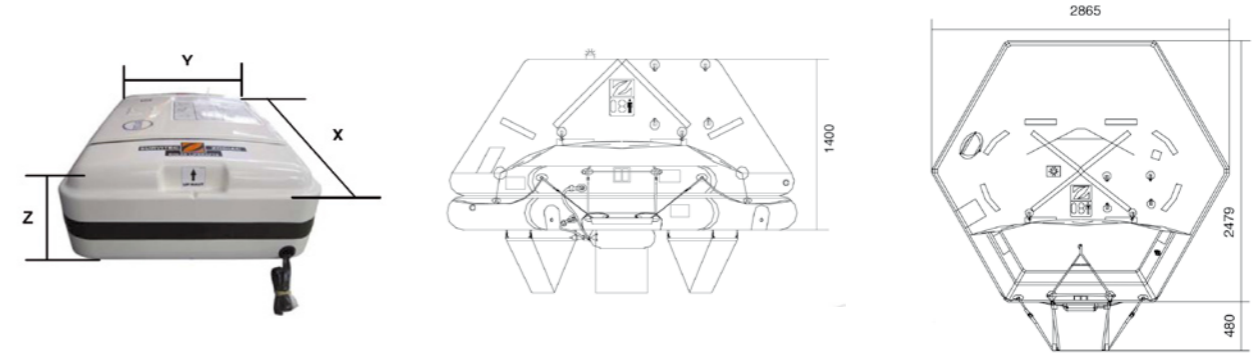

Code: MM ZOD 8PXTRE (A or B)

	SOLAS A PACK	SOLAS B PACK
Container	N138H	N138
Dimensions	X: 840 mm Y: 570 mm Z: 340 mm X: 2' 9,08" Y: 1' 10,45" Z: 1' 1,39"	X: 840 mm Y: 570 mm Z: 294 mm X: 2' 9,08" Y: 1' 10,45" Z: 11,58"
Liferaft Net Weight	74 kg / 164 pounds	57 kg / 126 pounds
Max Height stowage	25 m / 83'	25 m / 83'
Painter line length	35 m / 115'	
Inflation Cylinder	1 x 6,7 liter	
APPROVALS:	EC (MED) – BV – CCS	



**XTREM – LOW PROFILE CONTAINER 10 MAN THROW OVER BOARD LIFERAFT SOLAS A & B PACK**

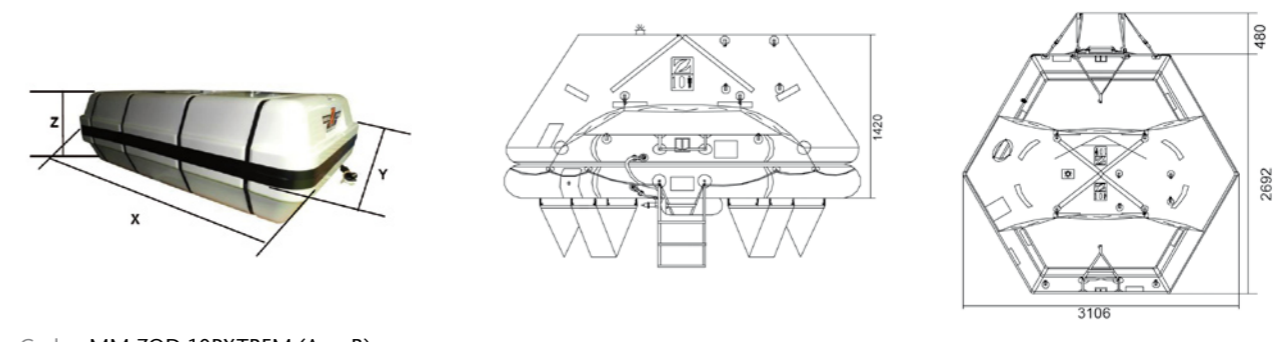

Code: MM ZOD 10PXTREM (A or B)

	SOLAS A PACK	SOLAS B PACK
Container	N139H	N139
Dimensions	X: 940 mm Y: 640 mm Z: 364 mm X: 3' 1,01" Y: 2' 1,2" Z: 1' 2,34"	X: 940 mm Y: 640 mm Z: 314 mm X: 3' 1,01" Y: 2' 1,2" Z: 1' 0,37"
Liferaft Net Weight	87 kg / 192 pounds	63 kg / 139 pounds
Max Height stowage	18 m / 60'	18 m / 60'
Painter line length	30 m / 99'	
Inflation Cylinder	1 x 6,7 liter	
APPROVALS:	EC (MED) – USCG – TC – BV – CCS	





**XTREM – LOW PROFILE CONTAINER 12 MAN THROW OVER BOARD LIFERAFT (NG) SOLAS A & B PACK**

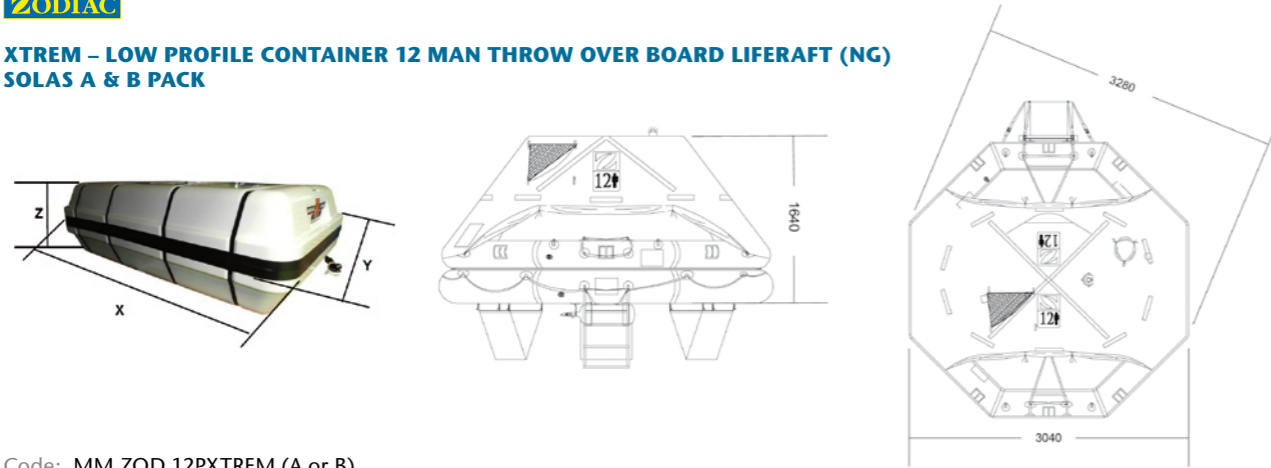

Code: MM ZOD 12PXTREM (A or B)

	SOLAS A PACK	SOLAS B PACK
Container	N139H	N139
Dimensions	X: 940 mm Y: 640 mm Z: 364 mm X: 3' 1,01" Y: 2' 1,2" Z: 1' 2,34"	X: 940 mm Y: 640 mm Z: 314 mm X: 3' 1,01" Y: 2' 1,2" Z: 1' 0,37"
Liferaft Net Weight	96 kg / 212 pounds	66,5 kg / 147 pounds
Max Height stowage	18 m / 60'	18 m / 60'
Painter line length	30 m / 99'	
Inflation Cylinder	1 x 8 liter	
APPROVALS:	EC (MED) – USCG – TC – BV	



**XTREM – LOW PROFILE CONTAINER 16 MAN THROW OVER BOARD LIFERAFT SOLAS A & B PACK**

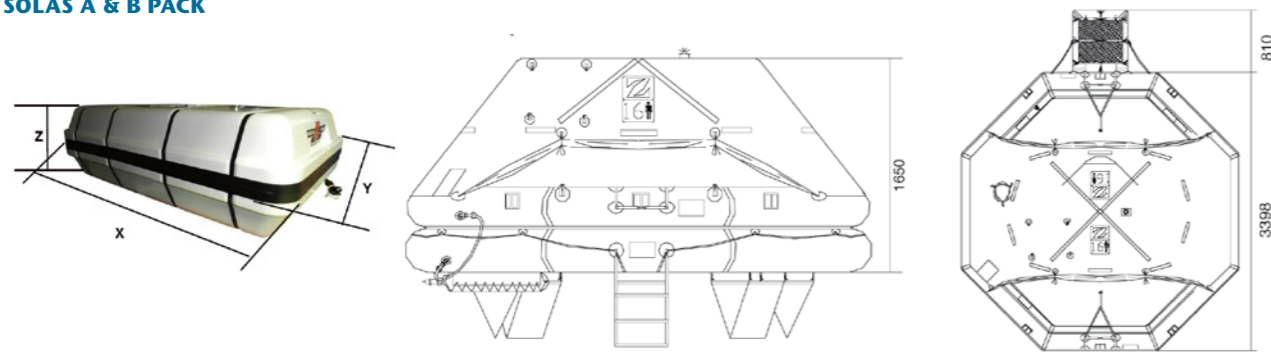

Code: MM ZOD 16PXTREM (A or B)

	SOLAS A PACK	SOLAS B PACK
Container	N140H	N140
Dimensions	X: 1100 mm Y: 650 mm Z: 370 mm X: 3' 7,31" Y: 2' 1,6" Z: 1' 2,57"	X: 1100 mm Y: 650 mm Z: 340 mm X: 3' 7,31" Y: 2' 1,6" Z: 1' 1,39"
Liferaft Net Weight	122 kg / 269 pounds	86 kg / 190 pounds
Max Height stowage	18 m / 60'	18 m / 60'
Painter line length	30 m / 99'	
Inflation Cylinder	1 x 15 liter	
APPROVALS:	EC (MED) – USCG – TC – BV – CCS	



**DK+ (SOLAS PACK A OR B)**



Rated Capacity	Code	Length mm	Diameter mm	Weight Kg*
4	MM VIK L004D000	990	490	59.50
6	MM VIK L006D000	1155	561	70
8	MM VIK L008D000	1155	561	86
10	MM VIK L010D000	1355	565	98
12	MM VIK L012D000	1355	656	109
16	MM VIK L016D000	1335	680	124
20	MM VIK L020D000	1335	685	150
25	MM VIK L025D000	1385	735	172
35	MM VIK L035D000	1550	890	282

\*Weight is meant for SOLAS Pack A.

**HYDROSTATIC RELEASE UNIT FOR LIFERAFTS – H20R**



- Designed for liferafts from 6 up to 150 persons
- Double looped white rope line, release mechanism and Red Weak Link™
- For smaller liferafts (from 4 persons and outside SOLAS regulation) Hammar H20 Small Rafts model is recommended
- If the ship sinks, the water pressure will, within 4 metres, activate the sharp knife which cuts the white strong rope and the liferaft will float free
- The Red Weak Link™ breaks and survivors can board the floating liferaft
- Easy to release with only one hand
- It needs no annual service, maintenance or spare parts
- It must be replaced every 2 years

Code: MM HMM H20R

Mounting instructions, how to use information, Approvals available on request.

**HOW TO ORDER YOUR NEW LIFERAFT:**

Code + SOLAS Pack A or B



**GET APP!**



Download our App and access the marine catalogues from your mobile device!

Survitec Zodiac SOLAS liferafts are also available in davit launched version.

Full technical data sheets, containers drawing, cradles, Certificates of Approvals for new liferafts available on request.

Liferafts brands we distribute:



We can take care of your liferafts annual inspection service from disembarkation to embarkation after service.

Contact our Safety Department, we'll get back to you with our basic quote.

Our Certified service station always use quality approved spare parts to ensure the longevity of your liferafts.

Service is carried out in compliance with your Flag and Class Registry requirements.



## FIRE FIGHTING EQUIPMENT



### BOAT A1 - DRY POWDER PORTABLE EXTINGUISHER



Code: MM MIN STD4112

- Dry powder rechargeable fire extinguisher
- RINA approved
- Nominal capacity 1 Kg
- Fire classes 5 A – 34 B - C
- Temperature range -30°C / +60°C
- Suitable for use on live electrical equipments up to 1000 V far at least 1 m

APPROVALS:  
According to standards EN 3-7 - PED 97/23/CE

### SKP 2P/M - DRY POWDER PORTABLE EXTINGUISHER



Code: MM MIN STD4082

- Dry powder rechargeable fire extinguisher
- MED approved
- Nominal capacity 2 kg
- Fire classes 13 A – 89 B - C
- Temperature range -30°C / +60°C
- Suitable for use on live electrical equipments up to 1000 V far at least 1 m

APPROVALS:  
According to standards EN 3-7 – SOLAS 74 – PED 97/23/CE  
According to MED 2008/67/CE

### SKP 3P/M - DRY POWDER PORTABLE EXTINGUISHER

Code: MM MIN STD4083



- Dry powder rechargeable fire extinguisher
- MED approved
- Nominal capacity 3 Kg
- Fire classes 21 A – 144 B - C
- Temperature range -30°C / +60°C
- Suitable for use on live electrical equipments up to 1000 V far at least 1 m

APPROVALS:  
According to standards EN 3-7 – SOLAS 74 – PED 97/23/CE  
According to MED 2008/67/CE

### SKP DRY P6/M - DRY POWDER PORTABLE EXTINGUISHER



Code: MM MIN STD4079

- Dry powder rechargeable fire extinguisher
- MED approved
- Nominal capacity 6 kg
- Fire classes 34 A – 233 B - C.
- Temperature range -30°C / +60°C
- Suitable for use on live electrical equipments up to 1000 V far at least 1 m

APPROVALS:  
According to standards EN 3-7 – SOLAS 74 – PED 97/23/CE  
According to MED 2008/67/CE

### SKP 6PS/M - DRY POWDER PORTABLE EXTINGUISHER

Code: MM MIN STD4084



- Dry powder rechargeable fire extinguisher
- MED approved
- Nominal capacity 6 Kg
- Fire classes 55 A – 233 B - C
- Temperature range -20°C / +60°C
- Suitable for use on live electrical equipments up to 1000 V far at least 1 m

APPROVALS:  
According to standards EN 3-7 – SOLAS 74 – PED 97/23/CE  
According to MED 2008/67/CE

### SKP 9P/M - DRY POWDER PORTABLE EXTINGUISHER

Code: MM MIN STD4085



- Dry powder rechargeable fire extinguisher
- MED approved
- Nominal capacity 9 kg
- Fire classes 55 A – 233 B - C
- Temperature range -30°C / +60°C
- Suitable for use on live electrical equipments up to 1000 V far at least 1 m

APPROVALS:  
According to standards EN 3-7 – SOLAS 74 – PED 97/23/CE  
According to MED 2008/67/CE





#### SKP 5CO2/M - CO2 PORTABLE EXTINGUISHER

Code: MM MIN STD4076



- Carbon dioxide (CO2) rechargeable fire extinguisher
- MED approved
- Nominal capacity 5 kg
- Fire classes 113 B
- Temperature range -30°C / +60°C
- Suitable for use on live electrical equipments up to 1000 V far at least 1 m

##### APPROVALS:

According to standards EN 3-7 – SOLAS 74 – PED 97/23/CE  
According to MED 2008/67/CE

#### 9 FOAM/M - FOAM PORTABLE EXTINGUISHER

Code: MM MIN STD4077



- Foam rechargeable fire extinguisher
- MED approved
- Nominal capacity 9 L
- Fire classes 34 A – 233 B
- Temperature range -5°C / +60°C
- Suitable for use on live electrical equipments up to 1000 V far at least 1 m

##### APPROVALS:

According to standards EN 3-7 – SOLAS 74 – PED 97/23/CE  
According to MED 2008/67/CE

#### 9 FRY FOAM/M - FOAM PORTABLE EXTINGUISHER

Code: MM MIN STD4080



- Foam rechargeable fire extinguisher
- MED approved
- Nominal capacity 9 L
- Fire classes 34 A – 233 B – (75 F)
- Temperature range -5°C / +60°C
- Suitable for use on live electrical equipments up to 1000 V far at least 1 m

##### APPROVALS:

According to standards EN 3-7 – SOLAS 74 – PED 97/23/CE  
According to MED 2008/67/CE

#### SKP 2CO2/M - CO2 PORTABLE EXTINGUISHER

Code: MM MIN STD4081



- Carbon dioxide (CO2) rechargeable fire extinguisher
- MED approved
- Nominal capacity 2 kg
- Fire classes 55 B
- Temperature range -30°C / +60°C
- Suitable for use on live electrical equipments up to 1000 V far at least 1 m

##### APPROVALS:

According to standards EN 3-7 – SOLAS 74 – PED 97/23/CE  
According to MED 2008/67/CE

#### 9 UNIVERSAL FOAM/M - FOAM PORTABLE EXTINGUISHER

Code: MM MIN STD4078



- Foam rechargeable fire extinguisher
- MED approved
- Nominal capacity 9 L
- Fire classes 43 A – 233 B
- Temperature range -5°C / +60°C
- Suitable for use on live electrical equipments up to 1000 V far at least 1 m

##### APPROVALS:

According to standards EN 3-7 – SOLAS 74 – PED 97/23/CE  
According to MED 2008/67/CE

#### 6L - FOAM FIRE EXTINGUISHER

Code: MM ABS 14361



- Foam rechargeable fire extinguisher
- MED Approved
- Nominal capacity 6 L
- Fire classes 27A - 233B
- Temperature range 0°C / +60°C
- It can be used on electrical equipment up to 1000 Volt at 1 mt distance minimum

##### APPROVALS:

EN3 approved – PED 97/23/EC  
According to Directive 96/98/EC MED



#### SUPER QUICK FIST



Code: MM DAV 00544

Super Quick Fist is a rubber clamp ideal to hold fire extinguishers, oxygen cylinders, CO2 tanks and other equipment. Mounts easily with three M10 (5 mm) bolts or screws. Holds objects from 64 to 191 mm in diameter. Each clamp supports approximately 23 kg. Mounting base 22 x 152 mm.

MANSUETO MARINE



#### SK 50 P/M - DRY POWDER RECHARGEABLE WHEELED EXTINGUISHER

Code: MM MIN STD4096



- Powder rechargeable wheeled fire extinguisher
- MED approved
- Nominal capacity 50 kg
- Fire classes A – IV B - C
- Temperature range -30°C / +60°C
- Suitable for use on live electrical equipments up to 1000 V far at least 1 m

##### APPROVALS:

According to standards EN 1866-1 - ISO 11601 – SOLAS 74 – PED 97/23/CE  
According to MED 2008/67/CE

#### SK50S/M - FOAM RECHARGEABLE WHEELED EXTINGUISHER

Code: MM MIN STD4097



- Foam rechargeable wheeled fire extinguisher
- MED approved
- Nominal capacity 50 L
- Fire classes A – IV B
- Temperature range -5°C / +60°C
- Suitable for use on live electrical equipments up to 1000 V far at least 1 m

##### APPROVALS:

According to standards EN 1866-1 - ISO 11601 – SOLAS 74 – PED 97/23/CE  
According to MED 2008/67/CE

#### CDM20 - CO2 RECHARGEABLE WHEELED EXTINGUISHER

Code: MM MIN STD4099



- Carbon dioxide (CO2) rechargeable wheeled fire extinguisher complete with hose and nozzle
- MED approved
- Nominal capacity 18 kg
- Fire classes 233 B
- Temperature range -30°C / +60°C
- Suitable for use on live electrical equipments up to 1000 V far at least 1 m

##### APPROVALS:

According to standards EN 1866-1 - ISO 11601 – SOLAS 74 – PED 97/23/CE  
According to MED 2008/67/CE

#### SK 150 IS/M - FOAM RECHARGEABLE WHEELED EXTINGUISHER

Code: MM MIN STD4098



- Foam rechargeable wheeled fire extinguisher
- MED approved
- Nominal capacity 150 L
- Fire classes A – IV B
- Temperature range +5°C / +60°C
- Don't use on live electrical equipments

##### APPROVALS:

According to standards EN 1866-1 - ISO 11601 – SOLAS 74 – PED 97/23/CE  
According to MED 2008/67/CE

Other fire extinguishers of different nominal capacities available on request.

We can take care of your fire extinguishers periodic/annual maintenance (refill, pressure/hydrostatic test, visual check, parts replacement) through our Certified service station according to local regulations.

Provisional fire extinguishers can be supplied (IF NEEDED) while yours are away for service.

We do service your CO2 fixed fire extinguishing system on board as well.

You may also need:

#### STOP 30 AEROSOL FOAM FIRE EXTINGUISHER

Code: MM COM STOP30



- STOP 30 aerosol foam fire extinguisher
- 730 GR, H.30CM, D.7,5 CM
- Quick and easy to use
- Biodegradable foam
- Fire classes ABF
- Maintenance-free

##### APPROVALS:

According to EU Directive 75/324//CEE and Afnor AF S 61 804

#### SPRAY MINI FLASH FIRE EXTINGUISHER

Code: MM BER 666-500ML



- Spray Mini Flash fire extinguisher 500 ML
- Quick and easy to use
- Biodegradable, non-toxic
- Fire classes ABCE
- For small fires in galley, boat, car

##### APPROVALS:

According to 75/324/CEE – 94/1/CE

www.mansuetomarine.it



**FIRE FIGHTING ACCESSORIES**



Fire-fighter hood, grey,  
Approved according to  
EN 13911

Code: MM VIK PS383567



Neck cover for Fire helmet

Code: MM VIK 1024862



Visor for fire helmet

Code: MM VIK 1024863



Fire helmet SOLAS/MED  
approved

Code: MM VIK 1033495

**FIRE BLANKET**



Fire blanket in  
soft bag 195 X 120 cm

Code: MM VIK 1022014

**TURBO NOZZLE**



Storz C brass adaptor

Code: MM VIK 1031253

**FIRE HOSE, STANDARD**



2", 25M, STORZ-C, aluminium

Code: MM VIK 1022681

**HEAVY DUTY FIRE HOSE**



2" 20m Storz C brass

Code: MM VIK 1025077

Other types of fire hose available on request, please specify:

- Hose length
- Coupling size
- Coupling material (Aluminium or Brass)

**FIRE-FIGHTING SUITS**



Complete Fireman's Outfit

- Components:
- two-piece fire-fighter suit
  - fire-fighter helmet with neck protection and visor
  - fire-fighter gloves
  - fire rubber boots
  - storage bag
  - one size outfit

Code: MM JON SI285L



Complete fire-fighter set

- Components:
- two-piece fire fighter suit (S to XXL), 100% Aramid
  - fibreglass helmet (one size)
  - NOMEX® gloves (8 to 12)
  - rubber boots (42, 43, 44, 45, 47)
  - storage bag

SOLAS MED 96/98 approved

Code: MM VIK PS37891054000



**DETECTORS**

	Code	Description
	MM APO 58000-600	Optical Smoke Detector Suitable for slow burning or smouldering fires To be positioned where these are most likely to occur.
	MM APO 58000-700	Multisensor Detector It comprises optical smoke and thermistor temperature sensors whose outputs can be reported individually. It allows to check separately the rise in temperature and the level of smoke.
	MM APO 58000-500	Ionisation Smoke Detector It uses a low activity radioactive foil to detect fires by irradiating the air in the smoke chambers and causing a current flow. General purpose detector responding well to fast burning and flaming fires.
	MM APO 58000-300	Carbon Monoxide Detector It is good at detecting deep-seated fires. It does not detect smoke particles or heat.
	MM APO 58000-400	Heat Detector Low airflow resistant case. Single thermistor to sense the air temperature around the detector. Useful where the environment is dirty or smoky under normal conditions.
	MM APO 58100-910	Manual Call Point It can be addressed at the commissioning stage by means of a seven-segment DIL switch. When operated, the MCP interrupts the polling cycle for a fast response.

**SMOKE DETECTOR TESTER**



- Non-flammable
- Oil-free formulation
- No lasting residue

250ml Canister

Code: MM SDT A3

**CARBON MONOXIDE DETECTOR TESTER**



Genuine and non-flammable  
CO stimulus

250ml Canister

Code: MM SDT C3

## BREATHING APPARATUS



RN/A 1603 T1 SCBA



Code: MM SPA 401520000



Self contained breathing apparatus Series MK2 Type 1 (Industrial)  
Complete set: cylinder, pressure reducer, automatic demand valve, mask, back plate and harness

**Technical Data**

Pressure Reducer: piston with compensator  
Automatic Demand Valve: with integral alarm device and supplementary supply button  
Setting of the Alarm:  $55 \pm 5$  bar  
Volume/pressure of Cylinder: 6 l/ 300 bar  
Air reserve: 1660 N liters  
Duration: 55 min at an average consumption of 30 l/min

**Use**

Maintenance intervention in chemical plants  
Industrial areas  
Contaminated surroundings  
Rescue intervention  
Oxygen deficiency

**Classification**

Certified Type 1 to EN137:2006 and meeting with directives 98/686/EEC (PPE), 97/23/EC (PED) and 96/98/ EC (PED)



RN/BN 1603 FR SCBA



Code: MM SPA 40407293



Self contained breathing apparatus Series MK2 Type 2 (Fire Fighters)  
Complete set: cylinder, pressure reducer, automatic demand valve, medium pressure hose, mask, back plate and harness

**Technical Data**

Pressure Reducer: piston with compensator  
Automatic Demand Valve: with integral alarm device and supplementary supply button  
Setting of the Alarm:  $55 \pm 5$  bar  
Volume/pressure of Cylinder: 6 l/ 300 bar  
Air reserve: 1660 N liters  
Duration: 55 min at an average consumption of 30 l/min for a single user

**Use**

For fire brigades  
Rescue team for fire fighting  
Polluted environments  
Oxygen deficiency

**Classification**

Certified Type 2 to EN137:2006 and meeting with directives 98/686/EEC (PPE), 97/23/EC (PED) and 96/98/CE (MED).

## STEEL ALLOY CYLINDERS



RN MK2 series can be equipped with steel cylinders of different volume and pressure capacity

Code	Volume and pressure capacity
MM SPA MK2-3L	3 lt 300 bar
MM SPA MK2-7L	7 lt 200 bar
MM SPA MK2-6L	6 lt 300 bar

Full range of MK2 Type 1 (industrial) and Type 2 (fire-fighters) BA available on request.

MANSUETO MARINE



Dräger

DRÄGER PSS® 7000



Compressed Air Breathing Apparatus, pneumatic gauge.  
Weight of complete set with Dräger FPS 7000 full-face mask, lung demand valve and Dräger 6.8 litre carbon composite cylinder, 20 year design life: 11.7 kg  
Input pressure: 0 – 300 bar  
Normal 1st stage output pressure: 7.5 bar  
1st stage output flow: > 1000 l/min  
Pneumatic warning whistle activation pressure: 50 – 60 bar  
Pneumatic whistle sound Level: > 90 dBA  
Operating Temperature: -30 - +60 °C

**Approvals**

Breathing Apparatus: EN 137: 2006 Type 2, vfdb 0802

Code				
MM DRA 3355068	Dräger PSS® 7000 Pneumatic Gauge	DIN Cyl. Thread connection	Single Cyl. Strap	Dräger PSS® 7000 SCS
MM DRA 3355930			Univ. Cyl. Strap	Dräger PSS® 7000 TCS
MM DRA 3356542		Cylinder Quick-Connect	Single Cyl. Strap	Dräger PSS® 7000 QC SCS

Dräger

DRÄGER FPS-COM-PLUS



Weight: depending on model 0.55 - 0.71 lbs. (250 - 320 g) (without battery)

**Approvals:**

ATEX: II 1G Ex ia IIC T5/T4 Ga (-30°C ≤ Ta ≤ +40°C/+60°C)

II 1D Ex ia IIIC T95°C/T130°C Da IP6x (-30°C ≤ Ta ≤ +40°C/+60°C)

IECEX: Ex ia IIC T5/T4 Ga (-30°C ≤ Ta ≤ +40°C/+60°C)

Ex ia IIIC T95°C/T130°C Da IP6x (-30°C ≤ Ta ≤ +40°C/+60°C)

NFPA: NFPA 1981: 2007 Edition

Battery types: AAA, Duracell PLUS or Duracell PROCELL (only due to ATEX approval)

Operation time: 4 to 24 hours (depending on usage profile, the operating time may be greatly reduced at extreme temperatures).

Ambient conditions for storage: 25°F to 75°F, 700 to 1300 hPa, 10 to 95% rel. humidity  
Protection class: IP 67

Code	Description
MM DRA R58818	Dräger FPS-COM-PLUS VA (voice amplifier only)
MM DRA R58820	Dräger FPS-COM-PLUS VA R-C Waris
MM DRA R58821	Dräger FPS-COM-PLUS VA R-C Jedi
MM DRA R58822	Dräger FPS-COM-PLUS VA R-C Nexus

Dräger

DRÄGER VALVE



Plus Lung Demand Valve (LDV)  
Short Hose Push in

Code: MM DRA 3338700

DRÄGER CYLINDER



Compressed air cylinder.  
6LT 300 bar steel cylinder

Code: MM DRA 3355002

www.mansuetomarine.it

## EMERGENCY ESCAPE BREATHING DEVICES



SK 1203 EEBD



Emergency escape breathing device  
Complete set: cylinder, valve/pressure reducer, breathing tube, hood, transport bag

**Technical Data**

Valve / Pressure Reducer: provided with gauge for the continuous reading of the cylinder charge  
Volume / Cylinder Working Pressure: 2 l / 300 bar  
Air reserve: 550 N litres  
Flow: about 36 l/min  
Autonomy : more than 15 minutes

**Use**

Self rescue  
Protection against fire fumes  
Lack of oxygen

**Classification**

Certified as a class 15 minutes device to EN 1146:2005 and meeting with directives 98/686/EEC (PPE), 97/23/EC (PED) and 96/98/EC (MED)

Code: MM SPA 403010000

SAVER EEBD



Constant flow Emergency escape breathing device  
10-minute supply of air  
Low-maintenance protection  
Transparent window on bag for cylinder pressure gauge checking  
Orange bag and photoluminescent panels for high visibility  
Alarm whistle sound before the air supply is exhausted

**Technical Data**

Size (H x L x D): 510 x 260 x 190 mm  
Cylinder charging pressure: 200 bar  
Airflow to the hood: 35-37 L/min  
Operating temperature range: -15 °C to +60 °C  
Weight (Kg) including cylinder: Soft bag 4.2 kg (CF10) - 5.2 kg (CF15)

**Use**

Protection against smoke and toxic fumes

**Classification**

EN1146 (2005), ISO 23269-1:2008, SOLAS Chapter II-2, the Marine Equipment Directive and the Pressure Equipment Directive.

Code	Description
MM DRA 3359735	Saver EEBD CF15 3 lt. 200 bar (Steel Cylinder)
MM DRA 3359734	Saver EEBD CF10 2 lt. 200 bar (Aluminium Cylinder)

MANSUETO MARINE



## DRÄGER PARAT C FIRE ESCAPE HOOD

**Technical Data**

Filter performance: Combination cartridge (gas & particle filter) provides protection against smoke, gases and particles

Filter Type: CO-P2

Approved duration: minimum of 15 minutes

Service Life: 12 years total (6 years maintenance free – filter and valve change required after 6 years)

Weight: approx. 600 grams

Dimensions: Dräger PARAT C Single-, Traveller-, Soft-Pack: 8 x 19 x 13,5 cm (H x L x W)

Dräger PARAT C Box: 18 x 19 x 8 cm (H x L x W)

Dräger PARAT C Twin-Pack: 9 x 33 x 22,5 cm (H x L x W)

Approval CE mark, tested according to EN 403 (H2S protection tested in accordance with DIN 58647-7)

	Code	Description
	MM DRA R52817	Dräger PARAT C Single-Pack, in a compact cardboard box
	MM DRA R52818	Dräger PARAT C Traveller-Pack, in a sturdy plastic case
	MM DRA R53555	Dräger PARAT C Soft-Pack, in a handy carrying case
	MM DRA R52845	Dräger PARAT C Twin-Pack, two escape hoods in a transparent wall-mounted box
	MM DRA R54105	Dräger PARAT Training hood
	MM DRA R57302	Spare parts kit Dräger PARAT C (including spare filter and exhalation valve)



OCENCO EEBD



	Code	Description
	MM ONC 1008018	Ocenco EEBD M-20.2 Compressed oxygen Up to 32 minutes of protection 15-year service life
	MM ONC 1008021	Ocenco EEBD M-20.2 Training Kit with video DVD and manual Complete with 2 extra mouth pieces Teaches donning from both the worn and stored position
	MM ONC 1008020	Bracket for Ocenco M-20.2 EEBD Stainless steel wall mounting bracket

www.mansuetomarine.it



## LIFE JACKETS & IMMERSION SUITS



### SKIPPER 150 INFLATABLE LIFEJACKET



Skipper 150 HX with harness



Inflated



Code	Size	Weight	Chest Size	Buoyancy	Inflation
SKIPPER 150					
MM VEL 09230	Adult/Junior	+40 Kg	80/125 cm	150 N	Automatic
MM VEL 09231	Adult/Junior	+40 Kg	80/125 cm	150 N	Manual
SKIPPER 150 HX (with harness)					
MM VEL 09235	Adult/Junior	+40 Kg	80/125 cm	150 N	Automatic
MM VEL 09236	Adult/Junior	+40 Kg	80/125 cm	150 N	Manual

Case made in technological high resistance fabric, with or without certified harness.

**Series accessories:** retroreflective tapes, whistle, lifting handle, rescue tape.



### SKIPPER 275 INFLATABLE LIFEJACKET



Skipper 275 HX with harness



Inflated



Code	Size	Weight	Chest Size	Buoyancy	Inflation
SKIPPER 275					
MM VEL 09670	Adult/Junior	+40 Kg	80/125 cm	275 N	Automatic
MM VEL 09671	Adult/Junior	+40 Kg	80/125 cm	275 N	Manual
SKIPPER 275 HX (with harness)					
MM VEL 09675	Adult/Junior	+40 Kg	80/125 cm	275 N	Automatic
MM VEL 09676	Adult/Junior	+40 Kg	80/125 cm	275 N	Manual

Inflatable lifejacket twin or mono-chamber, with or without certified harness, with automatic and/or manual activators.

Case made in technological high resistance fabric.

**Series accessories:** retroreflective tapes, whistle, lifting handle, rescue tape.



### ANTILLE 100N INEHERENT LIFEJACKET



Code	Size	Weight	Chest Size	Buoyancy
MM VEL 06211	XXS(*)	15 / 30 Kg	60 / 70 cm	> 40 N
MM VEL 06212	XS	30 / 40 Kg	70 / 80 cm	> 50 N
MM VEL 06213	S	40 / 50 Kg	80 / 90 cm	> 60 N
MM VEL 06214	M	50 / 70 Kg	90 / 100 cm	> 80 N
MM VEL 06215	L	70 / 80 Kg	100 / 110 cm	> 100 N
MM VEL 06216	XL	80 / 90 Kg	110 / 120 cm	> 110 N
MM VEL 06217	XXL	90+ Kg	120 / 130 cm	> 120 N

(\*) Equipped with padded crotch strap.

- Modular neck for greater protection of the head.
- Adjustment system: zip, waist belt w/quick release buckle adjustable crotch fastening straps.
- Signal system: retroreflective tapes, whistle.
- Rescue tape.
- Speed-up system.



### JET-PRO BUOYANCY AID



Code	Size	Weight	Chest Size	Buoyancy
MM VEL 05321	M	40 / 70 Kg	80 / 100 cm	> 55N
MM VEL 05322	L	70 / 80 Kg	100 / 110 cm	> 70N
MM VEL 05323	XL	80+ Kg	110 / 125 cm	> 80N

- For water skiing, jet ski, other active water sports.
- 4 adjustable straps with quick release buckles + D-ring to hook a safety lanyard.
- Padded ergonomic back protection.



### REEF BUOYANCY AID



Code	Size	Weight	Chest Size	Buoyancy
MM VEL 05379	S*	25 / 40 Kg	65 / 80 cm	> 40 N
MM VEL 05380	M	40 / 70 Kg	80 / 100 cm	> 55 N
MM VEL 05381	L	70 / 80 Kg	100 / 110 cm	> 70 N
MM VEL 05382	XL	80+ Kg	110 / 125 cm	> 80 N

(\*) Article equipped with crotch strap.

- For catamarans and rafting experts.
- 3 straps with adjustable quick release buckles + D-ring to hook a safety lanyard.
- Ergonomic and compact device.



### WIND BUOYANCY AID



Code	Size	Weight	Chest Size	Buoyancy
MM VEL 05313	S	25 / 40 Kg	65 / 80 cm	> 40 N
MM VEL 05314	M	40 / 70 Kg	80 / 100 cm	> 55 N
MM VEL 05315	L	70 / 80 Kg	100 / 110 cm	> 80 N

- For continuous use on canoes, kayaks and little sailing boats
- Straps, quick release buckle, waist elastic band + D-ring to hook a safety lanyard.
- High resistance to abrasions.



PASSION BUOYANCY AID



Code		Size	Weight	Buoyancy
Passion blue/yellow	Passion black/yellow			
MM PLS 27780	MM PLS 24092	S	30/50 Kg	70 N (certified in 50 N category)
MM PLS 27781	MM PLS 24093	M	50/70 Kg	70 N (certified in 50 N category)
MM PLS 27782	MM PLS 24094	L	70/90 Kg	70 N (certified in 50 N category)
MM PLS 27783	MM PLS 27778	XL	+ 90 Kg	70 N (certified in 50 N category)

- For water ski & jet ski.
- Polyethylene foam.
- Outer cover 100 % polyester.
- 4 fastening straps with buckles. Drawstring tightening at hem.
- Elasticated cutaway style around the arms for maximum freedom of movement.
- Good stomach and chest protection.



MODULO 150 INFLATABLE LIFEJACKET



Code	Size	Weight	Height	Colour	Harness
MM VEL 02140/A	Adult	+ 43 Kg	+155 cm	ORANGE	without harness
MM VEL 02140/A-HX	Adult	+ 43 Kg	+155 cm	ORANGE	with harness ISO 12401*
MM VEL 02140/B	Adult	+ 43 Kg	+155 cm	BLUE	without harness
MM VEL 02140/B-HX	Adult	+ 43 Kg	+155 cm	BLUE	with harness ISO 12401*

- Two chambers with UV resistant fabric cover.
- Buoyancy: >160N
- Equipped with Buddy System.\*\*
- Fleece neck.
- Back strap.
- Quick release buckle and frontal safety D-ring.

Colours



\* Certified Harness ISO 12401



\*\* Buddy System



MODULO 275 INFLATABLE LIFEJACKET



Code	Size	Weight	Height	Colour
MM VEL 02130/A	Adult	+ 43 Kg	+155 cm	Orange
MM VEL 02130/B	Adult	+ 43 Kg	+155 cm	Blue

- Two-chambers with UV resistant fabric cover.
- Buoyancy: >290N
- Fleece neck.
- Mesh back.
- Double quick release buckle.
- Reflective inserts.
- Equipped with Buddy System.

Colours



MK 10 LIFEJACKET



Code	Size	Weight	Height	Buoyancy
MM VEL 02005	Adult	+ 43 Kg	+155 cm	> 150N
MM VEL 02006	Child	15 - 43 Kg	100 - 155 cm	> 90N
MM VEL 02007	Infant	-15 Kg	-100 cm	> 65N
MM VEL 1119	Extension belt - Over Size			

- Foldable
- Retroreflective tapes
- Quick release buckle
- Rescue loop
- Waist belt for oversize people



PV9320 - VIKING INFLATABLE LIFEJACKET



Code: MM VIK PV9320



Buoyancy: 180 Newton, symmetrical

Approved according to SOLAS MSC 48(66) incl. 2010 amendments and EU-directive 96/98/EC

Dimensions:  
Packed: Approx 63 x 33 x 8 cm  
Inflated: Approx 67 x 42 x 16 cm  
Weight: Approx 1,5 kg

Complete with: light, whistle, reflective tape, lifting strap, buddy line and two automatic inflation systems. Crotch strap for added safety.



PV9313 - VIKING INFLATABLE LIFEJACKET - CHILD



Code: MM VIK PV9313



Buoyancy: 90 newton. From 15-43 kg.

Approved according to SOLAS MSC 48(66) incl. 2010 amendments and EU directive 96/98/EC

Dimensions:  
Packed: 28 x 43 x 6 cm  
Inflated: 37 x 53 x 15 cm  
Weight: 1,25 kg

Complete with: SOLAS approved light, whistle, crutch strap, lifting becket, buddy line.

Optional items:  
- Water activated light or Manually operated.  
- Halkey Roberts release unit or Hammar release unit.

Colours: red, blue, black, high visible yellow.

FIND US ON facebook!  
[www.facebook.com/mansuetomarine](http://www.facebook.com/mansuetomarine)





WHISTLE



Code: MM VEL 25180



LIFEJACKETS LIGHTS



03016/A1-03017/A1-03019-03020



Asteria 03031



Electric Fuel 03033



03037/03038

Code	Description
MM VEL 03016/A1	Jack Automatic, alk battery, Alcares ARH
MM VEL 03017/A1	Jack Manual, alk battery, Alcares A1
MM VEL 03019	Jack Automatic, lithium battery, Alcares
MM VEL 03020	Jack Manual, lithium battery, Alcares
MM VEL 03031	Manual, Asteria
MM VEL 03033	USCG 161012/43/0 approved
MM VEL 03037	Automatic, DAN W3
MM VEL 03038	Manual, DAN-M3



WATER ACTIVATED LED LIFEJACKET LIGHT



AQ40S



AQ40L

Code	Weight	Description
MM AQC AQ40S	29 gr	With built-in sensor points
MM AQC AQ40L	39 gr	With sensor lead



LIFEJACKET INFLATOR MA1 EC



Single point indicator model.  
Automatic hydrostatic activator. Rearing kit.

Code: MM VEL V90000TG60

HALKEY | ROBERTS®

AUTOMATIC ACTIVATOR V90000 TG60



Code	Description
MM VEL 25003	green indicator clip
MM VEL 25002	yellow salt bobbin
MM VEL 25004	auto head

MANSUETO MARINE



NEOPRENE IMMERSION SUIT



Code: MM VIK PS2014

- Height: from 140 to 200 cm
- Weight from 50 to 100 kg
- Outer fabric: 5mm neoprene
- Sewing thread: polyester
- Retro-reflective trim
- Wristlets: neoprene cuffs with strap for adjustment
- Detachable gloves attached at wristlets
- Neoprene boots fitted with rubber soles and hook/loop intake

PU COATED NYLON INSULATED IMMERSION SUIT



Code: MM VIK PS5002

- One size: Height from 140 to 200 cm. Weight from 50 to 100 kg
- Oversize: Height from 190 to 210 cm. Weight from 100 to 160 kg
- Quilted, blue polyester lining, insulation 300 g/m<sup>2</sup>
- Heat-resistant sewing thread
- Soft buoyancy foam in back, adjustable braces inside the suit for adjustment of height, detachable gloves attached at each wristlet, boots are fitted with PU soles and hook/loop intake, buddy line, light and whistle. Comes in a bag.
- For navy, fishing vessels, offshore, cargo, passenger ships and yachting.



IMMERSION SUIT 8800 BUOYANCY PLUS



Code: MM CSV 8800

- 5mm fire retardant neoprene construction
- Buoyancy pillow: the suit can be worn without a lifejacket
- Supplied in a carry bag
- SOLAS grade retro-reflective tape, whistle, buddy line
- Sizes: universal, L, XL
- Optional extras:
  - 5mm neoprene gloves with PVC dot palm
  - SOLAS approved light
  - Lifting strop with S/S D-ring

8800 (Variety of options available)



SURVIVAL SUIT ISS-590 I



Code: MM YGP ISS590I

- 6 hours thermal protection
- Inflatable head support: the suit can be worn without a lifejacket
- Supplied in colour coded storage bag
- Reflective panels, whistle, insulated 5-finger gloves, light pocket
- Non-slip soles
- Ankle and wrist adjustments for a snug fit



THERMAL PROTECTIVE AID



- Protects against rain, wind and cold temperatures in liferafts and lifeboats
- Welded and water tight seams. Metallised inside layer to retain body heat
- XL zipper to accommodate even a mother with a small child
- Includes retro reflective tape
- Available with or without sleeves

Code: MM VIK 1032814

www.mansuetomarine.it



## LIFEBUOYS RINGS



### VIRGO – SOLAS LIFEBUOY – COMPACT VERSION



Code	Weight	Dimension
MM VEL 12010	2,5 Kg	EXT. 62,5 - INT. 40,5 cm

### FABRIC CASE FOR VIRGO LIFEBUOY



Code: MM VEL 14022



### ALTURA – SOLAS LIFEBUOY



Code	Weight	Dimension
MM VEL 12000	2,5 Kg	EXT. 72 - INT. 43,5 cm
MM VEL 12005	4 Kg	EXT. 72 - INT. 43,5 cm

### STAINLESS STEEL HOLDER FOR ALTURA LIFEBUOY



Code: MM VEL 14005



### OSCULATI

#### LIFEBUOY RING WHITE – ORANGE



Code: MM OSC 2240709

Anti-petrol plastic foam, electrowelded PVC coated  
External Ø 61 cm

#### LIFEBUOY RING ORANGE



Code: MM OSC 2240702

Orange Eltex filled with expanded polyurethane  
Ø 35 x 60 cm



Download our App and access the marine catalogues from your mobile device!



MANSUETO MARINE



### RING LIFEBUOY MOD. «ORCA»



Ø 57 x 34 cm  
Covered by PVC entirely welded.  
Inside in polystyrene resisting to oil.  
Complete with line.

Code	Background	Bands	Weight
MM TRM N1455030	White	Red	400 gr.
MM TRM N1455075	White	Blue	400 gr.

### RING LIFEBUOY MOD. «CORALLO»

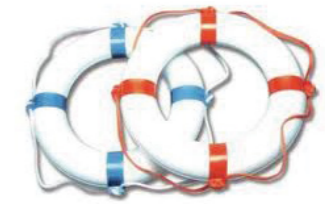

Ø 65 x 40 cm  
Covered by PVC entirely welded.  
Inside in polystyrene resisting to oil.  
Complete with line.

Code	Background	Bands	Weight
MM TRM N1465040	White	Red	800 gr.
MM TRM N1465075	White	Blue	800 gr.

Horseshoe lifebuoys (polyethylene and soft expanded ethafoam type) and relative covers and holders, other types of SOLAS and NON SOLAS life saving floating devices also available.



### SOLAS FLOATING LIFEBUOY LIGHT (WITHOUT BATTERY)



Code: MM VEL 14040



### SOLAS 360 LIGHT WITH PHOTOCELL



Code: MM VEL 25040



### SOLAS FLOATING LIFEBUOY LIGHT WITH BATTERIES IN CLOSED BOX AND HOLDER



Code: MM VEL 14009



### LIFEBUOY FLASHING LED LIGHT L160



Yellow body + black bracket  
Auto activation via pull cord

Code: MM DNM 62001A

www.mansuetomarine.it

**OSCULATI**

**SOLAS STARLED FLOATING LIGHTY BUOY**

Automatic switching-on, 145x105mm  
4xAA batteries



Code: MM OSC 3058200

**OSCULATI**

**MAYDAY STROBOSCOPIC LIGHT**

Fitted with nylon straps with Velcro  
Duration 8 h, 40x120mm



Code: MM OSC 3058600

**OSCULATI**

**STAINLESS STEEL UNIVERSAL LIFEBUOYS HOLDER**



Code: MM OSC 2242500



With dan buoy light support

Code: MM OSC 2242600



**CARRY BAG FOR LIFEBUOY RING**

Stuffed polyester fabric, PVC inside  
White colour



Code	Model	Colour	Size
MM TRM N1468074	Astra	White	Ø 68cm
MM TRM N1468075	Astra	Blue	Ø 68cm
MM TRM N1478074	Taurus	White	Ø 78cm



**POLYETHYLENE FLOATING LINE ROLLS**

Orange.  
Sold by linear meter.



Code	Diameter mm	Length m	Strength kg
MM LZS 98067	4	200	120
MM LZS 98991	6	200	145
MM LZS 98992	8	200	400
MM LZS 98993	10	100	807



**PRE-CUT POLYETHYLENE FLOATING LINES**

Orange.



Code	Diameter mm	Length m	Strength kg
MM LZS 90834	6	15	145
MM LZS 94801	6	30	145
MM LZS 90835	8	15	400
MM LZS 70260	8	30	400
MM LZS 90836	10	15	807

MANSUETO MARINE



**HAMMAR**

**LIFESAVER LS101**



- Self-inflating horseshoe lifebuoy
- Rugby-ball shape
- Easy to throw into the wind
- It acts as a lift anchor, does not blow away
- Compact and easy to reach
- Clearly visible in the water
- Fits people of all sizes, including children
- Very durable
- Can be re-armed after use
- Easy to fasten around the body
- A person wearing the lifebuoy can be lifted
- It is possible to swim while wearing the lifebuoy
- Easy to remove from its holder
- Attractive design

Code: MM HMM LS50-0100

**Accessories**



Stainless steel holder with bracket  
for 25 mm tube

Code: MM HMM LS50-0201



Stowing box

Code: MM HMM LS50-0202



Re-arming kit

Code: MM HMM LS50-0203

We deliver ALL OVER EUROPE  
MORE THAN 1.000.000 articles on stock  
24/7 Express DELIVERY to the Mediterranean  
WITH OUR OWN MEANS OF TRANSPORT



www.mansuetomarine.it

## SAFETY BELTS



### SAILING MAST ASCENDER



Kit for ascending the masts of boats. As shown in the figures it can be used in the following modes:  
 fig. 1 - solo climbing, with bosun chair and hoist.  
 fig. 2 - with help and bosun chair with hoist. It works on textile halyards from 8 to 13 mm and not on wire cables. Max operator weight: 100 kg. Bag included.

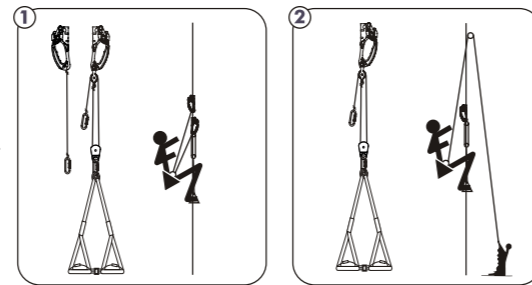

Code: MM KNG 200SET02



### BOSUN'S CHAIR



Suitable for mast climbing. Made of very thick nylon fabric, filled with expanded foam, it provides safety and at the same time gives freedom of movement. Fitted with side object-holder pocket and tool rack. Available in one size only.

Code: MM OSC 2309000  
MM OSC 2309100



### LIFE LINES FOR SAFETY BELTS



Made with special rounded edges straps and stainless steel hooks.

Code	Length m	Hooks	Breaking load
MM OSC 2315170	2,5	2 snap hooks AISI 316 100 mm	1200 kg
MM OSC 2315171	3	3 snap hooks s/s 100 mm *	2000 kg

\* Professional type fitted with 1 buckle always hooked onto the lifeline, the third one alternates with the second one when it shifts.

MANSUETO MARINE



### EURO LIGHTLINE SAFETY BELT



Code	N. hooks	S.S. hooks type	Length
MM OSC 2315600	2	with safety belt	2
MM OSC 2315601	2	fast safety and anti-caughting opening	2
MM OSC 2315602	2 + 1 central	fast safety and anti-caughting opening	2



### SAFETY LIFE BELTS "EURO HARNESS"



Approved by EC certification type no. CCE 809998/1. Made of soft polyester straps with quick locking stainless steel buckle.

Code	Size
MM OSC 2315501	adults - over 50 kg
MM OSC 2315502	kids - 20/50 kg
MM OSC 2315503	babies - up to 20 kg



### SAFETY BELT "EURO SPRING LINE III"

The elastic part extends from 1 metre to 2 metres + 1 metre on the fixed part. Includes accident-proof safety carbine hooks.

Code: MM OSC 2315166



### ELASTIC SAFETY BELT "EURO SPRING LINE II"

It extends from 1 to 2 metres, includes accident-proof safety carbine hooks, type-approved under certification no. PPE 400304CS/1.

Code: MM OSC 2315167



### ELASTIC SAFETY BELT "EURO SPRING LINE"

Stainless steel safety hooks, universal size; Type-approved by EC certification no. PPE 400304CS/2. Min. Length: 1 m. - Max Length: 2 m.

Code: MM OSC 2315168

www.mansuetomarine.it







**SAFETY BELTS + HARNESS COMBO, FOR MAST CLIMBING**

Made of strong nylon/cordura tissue with semi-rigid padded back. Straps in high resistance soft polyester.  
23.094.02 model is equipped with extra straps for legs or shoulders when used as harness so that the traction is distributed on the whole body.

Code: MM OSC 2309401  
MM OSC 2309402



**MAST PRO HARNESS DW-MPH**

Lightweight  
Quick adjust twin 'doubleback' buckles in marine grade stainless steel  
Extra tough Cordura™ leg strap covers – protect against abrasion damage to harness  
Ergonomic sculptured waist belt  
Super wide leg straps for added comfort and lumbar support  
Neoprene buckle covers prevent snagging and damage to the rig  
Replaceable elastic leg straps  
Tripping spike pocket  
Tool attachment points

Code: MM SPN DWMPH



**SAFETY HARNESS**

Type with side and back attachment - UNI-EN 361-358  
With high-strength polyester thread stitching  
Complete with positioning belt with comfortable, ergonomic back, height 130 mm  
Adjustable polyester straps, width 45 mm  
Adjustment with a single thigh-protection buckle  
Side steel «D» rings with easy-sliding nylon loops  
Size M+XL

Code: MM ABC M 3466/5000



**BOSUN'S CHAIR MOD. "SAILING"**

PVC coated cloth. with wrap-around back  
2 pockets and a storage pocket  
Size. 44x43 cm  
Weight: 900 gr

Code: MM TRM B1000900



**Our Certified Service Station can perform your lifting gear and equipment's annual inspection on board.**  
Safety helmets, gloves, hooks and shackles, stretchers, slings also available.



**MARINE MEDICAL & FIRST AID KITS**

**CODE OF PRACTICE CAT "C" COMMERCIAL FIRST AID KIT (BOXED) 1998**

Complies with EEC Directive 92/29  
MCA approved  
Complies with Codes of Practice MSN 1768 (M&f)  
Multi-lingual instructions included  
Re-sealable foil bag  
Weight: 2,62 kg

Code: MM OCE MED0130

Code: MM OCE MED0125 (Empty first aid box)



Content	Description	Quantity
Dressings:	Small Standard Dressing No. 13 or No. 8 BPC	6
	Medium Standard Dressing No. 14 or No. 9 BPC	2
	Large Standard Dressing No. 15 BPC	2
	Sterile Paraffin Gauze Dressings BP 10 x 10 cm	10
	Calico Triangular Bandages BP 90 x 127 cm	4
	Sterile Absorbent Cotton Gauze BP 30 x 90 cm	1
Plasters:	Adhesive Elastic Dressing BP 7.5 cm x 4 m	1
	Assorted Sterile Adhesive Plasters	20
	Zinc Oxide Plaster BP 2.5 cm x 5 m	1
Miscellaneous:	Laerdal-type Pocket Mask	1
	Cetrimide Cream 0.5% W/W 50-g Tube BP	1
	Disposable Large Polythene Gloves	5 pairs
	Burn Bag approx. 46 x 31 cm	1
	Disposable or Stainless Steel Sterile Scissors	1
	Rustless Medium Safety Pins	1
	Antiseptic Wipes 0.015% with Chlorhexidine	
	H/V 0.015% Cetrimide	1
	Codeine Phosphate 30-mg tablets	20
	Glyceryl Trinitrate 400 mg/metered 200 dose or	1 unit
Tablets/Medicines:	5-mg Transdermal Patches	2
	Hyoscine Hydrobromide 0-3 mg BP Tablets	60
	Paracetamol 500-mg Tablets	50
	Instructions:	Waterproof Paper in English, German, French, Spanish, Danish

**COMMERCIAL FIRST AID CATEGORIES**

- **Cat.A:** for vessels operating more than 150 miles from a port.
- **Cat.B:** for vessels operating less than 150 miles from a port but within rescue service range.
- **Cat.C:** for vessels operating less than 30 miles from a port (including lifeboats and commercial liferafts).

## INSHORE FIRST AID KIT



- It comes in a compact water resistant robust box.
- Ideal for the inshore sailor or rib user.
- Weight: 0.35 kg

Code: MM OCE MED0500

Content	Quantity
Assorted plasters	12
Eye pad	1
Triangular bandage	1
Safety pins	6
Medium sized dressing	1
Large sized dressing	1
First aid guidance leaflet	1
Alcohol free moist wipes	6
Bandage conforming 7.5cm	1
Pair disposable gloves	1
Pair tuff-cut scissors	1
Yellow clinical waste bag	1
Emergency foil blanket	1
Face shield resuscitation device	1

Contact us at [info@mansuetomarine.it](mailto:info@mansuetomarine.it) for other medical kits.  
Quotes for Category A & B kits available on request.



## EVOLUTION PLUS 2X500ML EYE WASH KIT WITHOUT MIRROR



- Features two 500ml bottles of sterile eye wash solution
- Kit also includes two sterile eye pad dressings for treating wounds
- Self supporting workbench allows kit to be opened and worked with on the bracket
- Quick release bracket and carrying handle enables kit to be taken to the incident location
- Durable hinged case includes bottle stabilizers to hold contents firmly in place

Code: MM SFA E459T



## EYE CARE STATION WITH MIRROR



- Robust, wall-mounted eye wash station
- Incorporates 2x500ml bottles of sterile saline eye wash solution
- Integrated mirror is ideal for self-administration of eye wash
- Clear instruction panel indicates correct use of eye wash
- Wall fixings not supplied

Code: MM SFA E481



## EYE CARE STATION WITH MIRROR



- Emergency eye irrigation for any workplace environment. Ensure you have adequate eyewash facilities at your place of work
- 0.9% sterile saline solution is ideal for irrigating eyes and general wound washing applications
- For irrigating eyes that have been contaminated with particles or liquids

Code: MM SFA E404

MANSUETO MARINE



## LIFE SAVING DEVICES



## Resuscitator

Code: MM VIK 1009041

- PVC Bag 1600 ml with PVC mask size 4 and overpressure valve
- Manually operated



## Resuscitator SPENCER flex mask with orange PVC case

Code: MM VIK 1009043

- The oxygen port is built directly into the mask
- The one-way valve has a mouth-piece for both victim and rescuer.



## Resuscitator Pack

Code: MM VIK 1025082

- Oxipack bag with 2 litre empty oxygen cylinder
- Adult oxygen mask and pressure reducer with flow select
- Delivered with empty cylinder



## Defibrillator

Code: MM VIK 1057868

- Defibrillator LIFEFORCE, 5 Year, AED (Automated External Defibrillator)
- LIFEFORCE automated external defibrillator is simple to use. It guides its user with clear verbal and visual instructions through each step of rescue. It automatically detects when defibrillation is required, ensuring that treatment will only be delivered when needed.

## Medical Oxygen Bottles available upon request

- New Supply
- Periodical Service, Test, Refill



GET APP!





www.mansuetomarine.it

## SECURITY ON BOARD



CCTV MARINE CAMERAS

	Code	Model	Description	Pack Contents
	MM GRM 0101137210	GCL 20	Low-Light Camera, PAL 28 x optical, 12 x digital zoom capabilities (PTZ) Dimensions: 163mm x Ø 130 mm Weight: less than 3 lbs Image resolution: 768x494	- Video/Power/NMEA 2000 Cable - NMEA 2000 T-Connector - BNC/RCA Adapter - Installation Kit Mounting Plate - User Manual Documentation
	MM GRM 0101137211	GCL 20	Low-Light Camera, NTSC Same features as per PAL version	
	MM GRM 0101137220	GCT 20	Thermal Camera, QVGA+, 9Hz 44% more pixels than regular QVGA 1x to 8x continuous digital zoom (PTZ) Dimensions: 163mm x Ø 130 mm Weight: less than 3 lbs Image resolution: 384x288 5 definable scene models	
	MM GRM 0101137221	GCT 20	Thermal Camera, QVGA+, 30Hz Same features as per QVGA+, 9Hz version	
	MM GRM 0101137230	GCT 30	Thermal Camera, VGA+, 9Hz 1x to 12x continuous digital zoom Dimensions: 163mm x Ø 130 mm Weight: less than 3 lbs Image resolution: 640x480 5 definable scene models	
	MM GRM 0101137231	GCT 30	Thermal Camera, VGA, 30Hz Same features as per VGA, 9Hz version	

## Panasonic

SUPER DYNAMIC III DOME CAMERA WV-CS954



Code	Model	Description
MM PAN WVCS954	WV-CS954	Day/night surveillance dome camera 30 x optical zoom lens, 10 x digital zoom Colour and B/W Auto tracking Power: 24V AC, 60 Hz Dimensions: 9.1875" x 6.0625" Weight: 4.84 lbs

FIND THE NEW PRODUCTS ON LINE  
www.mansuetomarine.it



MANSUETO MARINE



## Panasonic

SUPER DYNAMIC HD DOME NETWORK CAMERA WV-SW355



Code	Model	Description
MM PAN WVSW355	WV-SW355	Vandal resistant fixed dome network camera True day/night, colour Face detection Lens: 2.8-10mm HD resolution 1280x960 H.264 (High profile) dual stream and JPEG output Power: 12V DC Dimensions: 6 <sup>15</sup> / <sub>32</sub> " x 7 <sup>7</sup> / <sub>16</sub> " (H x W) Weight: 3.53 lbs

## Panasonic

VANDAL PROOF WATER / DUST RESISTANT DOME CAMERA WV-CW364



Code	Model	Description
MM PAN WVWC364	WV-CW364	Water and dust resistant IP66 dome camera Vandal proof for high reliability Day/night technology 3 way hinge (horizontal, vertical and swivel rotation) Colour and B/W mode Focal length of lens 2.8 mm-10mm Dimensions: ø164 mm x 146 mm (H), 191.5 mm (Base Cover) Weight: 2.31 lbs



RAT GUARDS



Code	Description	Suitable for:
MM SWI 1122	Rat Guard PVC/polystyrene D.30 cm	lines up to D.30mm
MM SWI 1124	Rat Guard PVC/polystyrene D.45 cm	lines up to D.45mm
MM SWI 1125	Rat Guard PVC/polystyrene D.75 cm	lines up to D.75mm

RAT GUARDS

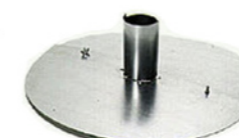

Code	Description
MM TRM N3510180	Clear plastic rat guard, UV resistant
MM CAC788A	Zinc plated rat guard D.60cm

www.mansuetomarine.it



### High Security Fencing:

- > Galvanized Steel Z275 (G90)
- > Stainless Steel AISI 430
- > Stainless Steel AISI 304



#### CONCERTINA ® ARROW BLADES

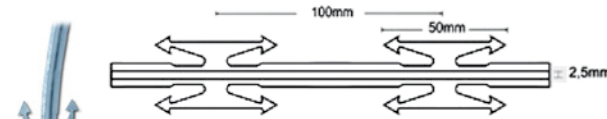

Concertina ® with long blades of 12 spikes, creating a hook effect, particularly resistant. Reinforcement of core wire. The most resistant exclusive model.

Code	Thickness	Wire Diameter	Blade Length	Blade Width	Distance Between Blades
MM ESF AB	0,5mm	2,5mm	50mm	36mm	100mm



#### CONCERTINA ® 10

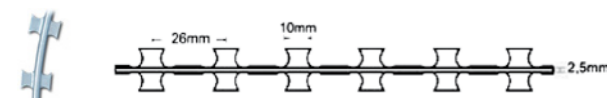

Concertina ® with small blades, without extra reinforcement of the wire, but with high capacity for deterrent. Standard, with great efficiency.

Code	Thickness	Wire Diameter	Blade Length	Blade Width	Distance Between Blades
MM ESF 10	0,5mm	2,5mm	10mm	13mm	26mm

Concertina ® 15 model also available: blade length and width 15 mm, distance between blades 33 mm.



#### CONCERTINA ® 22

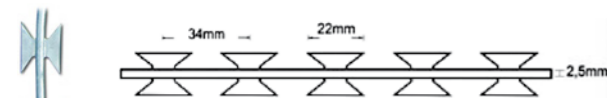

Concertina ® with medium sized blades and high diffusion. Standard with great efficiency and resistance.

Code	Thickness	Wire Diameter	Blade Length	Blade Width	Distance Between Blades
MM ESF 22	0,5mm	2,5mm	22mm	15mm	34mm

Other types of security fencing, wide range of blades for several uses and installations, available according to your needs.



#### CONCERTINA ® 25

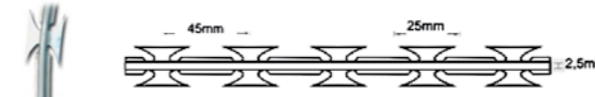

Concertina ® with medium sized blades with extra reinforcement of core wire. A balance between deterrent and resistance.

Code	Thickness	Wire Diameter	Blade Length	Blade Width	Distance Between Blades
MM ESF 25	0,5mm	2,5mm	25mm	16mm	40mm

Concertina ® 28 model also available: blade length 28 mm, width 16 mm, distance between blades 33 mm.



#### CONCERTINA ® L-TYPE

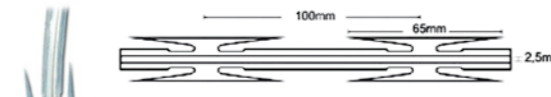

Concertina ® long blade with extra reinforcement center. The more extended model.

Code	Thickness	Wire Diameter	Blade Length	Blade Width	Distance Between Blades
MM ESF LTYPE	0,5mm	2,5mm	65mm	21mm	100mm



#### CONCERTINA ® H TYPE

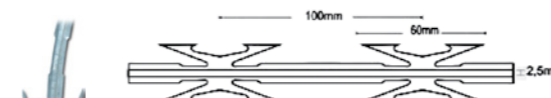

Concertina ® with long blades of 8 spikes, creating a hook effect. Reinforcement of core wire. The most aggressive standard model.

Code	Thickness	Wire Diameter	Blade Length	Blade Width	Distance Between Blades
MM ESF H	0,5mm	2,5mm	60mm	30mm	100mm



#### CONCERTINA ® SUPER H TYPE

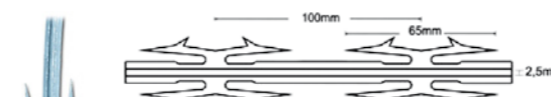

Concertina ® with long blades of 8 spikes, creating a hook effect, particularly sharp. Reinforcement of core wire. The most aggressive exclusive model.















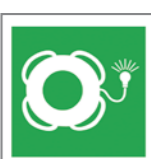

Code	Thickness	Wire Diameter	Blade Length	Blade Width	Distance Between Blades
MM ESF SH	0,5mm	2,5mm	65mm	30mm	100mm

# IMO SIGNS

**Material:**

- > a) Photoluminescent, self adhesive vinyl (AL)
- > b) Photoluminescent, rigid PVC (RL)

Standard sizes (mm):	A: 75x75	D: 300x100	N: 500x500	S: 390x130
	B: 50x50	E: 150x200	P: 75x150	T: 450x100
	C: 150x150	F: 200x200	Q: 300x300	Y: 300x150

 Lifeboat MM CAI CA4500CNQ	 Rescue Boat MM CAI CA4501C	 Liferaft MM CAI CA4502C	 Davit Launched Liferaft MM CAI CA4503C
 Embarkation Ladder MM CAI CA4504C	 Evacuation Slide MM CAI CA4505C	 Lifebuoy MM CAI CA4506C	 Lifebuoy With Line MM CAI CA4507C
 Lifebuoy With Light MM CAI CA4508C	 Lifebuoy W/light & Smoke MM CAI CA4509C	 Lifejacket MM CAI CA4510CABQ	 Child's Lifejacket MM CAI CA4511CB
 Immersion Suit MM CAI CA4512C	 Survival Craft Portable Radio MM CAI CA4513C	 Epirb MM CAI CA4514C	 Radar Transponder MM CAI CA4515C















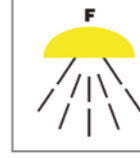
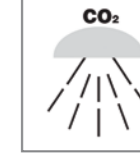

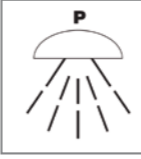
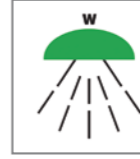
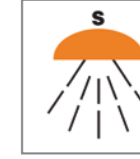

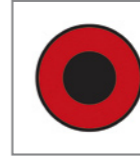
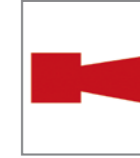

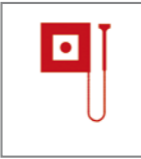
 Survival Craft Distress Signal MM CAI CA4516C	 Rocket Parachute Flares MM CAI CA4517C	 Line Throwing Appliance MM CAI CA4518C	 Muster Station MM CAI CA4519CNQ
 Evacuation Chute MM CAI CA4112C	 Stretcher MM CAI CA6562C	 Thermal Protective Aid MM CAI CA4121C	 Anti-Exposure Suit MM CAI CA4113C
 Breathing Apparatus MM CAI CA4101CAB	 Infant Lifejacket MM CAI CA4119CB	 Medical Locker MM CAI CA6550C	 Number "0" MM CAI CA6520P-Y
 Number "1" MM CAI CA6521P	 Number "2" MM CAI CA6522P-Y	 Number "3" MM CAI CA6523P-Y	 Number "4" MM CAI CA6524P-Y
 Number "5" MM CAI CA6525P	 Number "6" MM CAI CA6526P-Y	 Number "7" MM CAI CA6527P-Y	 Number "8" MM CAI CA6528P-Y
 Number "9" MM CAI CA6529P-R	 Letter "A" MM CAI CA6530P-Y	 Letter "B" MM CAI CA6531P-Y	 Letter "C" MM CAI CA6532P-Y

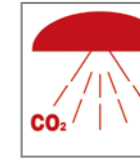





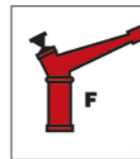



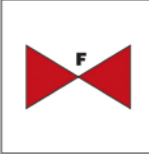

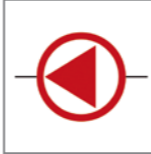

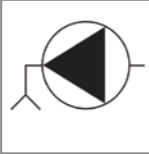
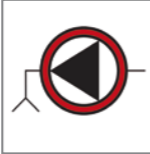

Safety Locker MM CAI CA4114C	Lifejackets Under Seats MM CAI CA4237E	Emergency Shower MM CAI CA4108C	Emergency Eye Wash MM CAI CA4107C
Emergency Telephone MM CAI CA4103C	Emergency Stop MM CAI CA6563C	General Alarm MM CAI CA4115C	First Aid MM CAI CA4236E
First Aid MM CAI CA4313D	Stretcher MM CAI CA4309D	Emergency Equipment MM CAI CA4302D	Protective Equipment MM CAI CA4319D
Safe For Entry MM CAI CA4320D	Emergency Shower MM CAI CA4308D	Emergency Eye Wash MM CAI CA4307D	Emergency Telephone MM CAI CA4303D
Emergency Stop MM CAI CA4311D	Drinking Water MM CAI CA4306D	Pollution Control Equipment MM CAI CA4318D	Breathing Apparatus MM CAI CA4301D
Smoke Hood MM CAI CA4314D	Safety Equipment MM CAI CA4325D	Smoking Area MM CAI CA4317D	Eating and Drinking Area MM CAI CA4328D

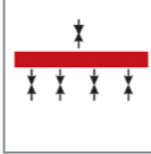



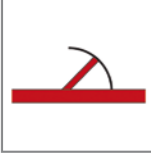
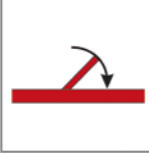

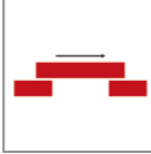
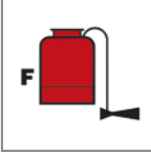

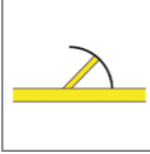
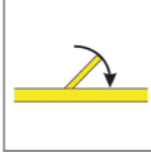

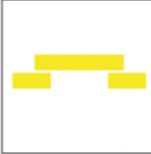
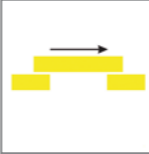





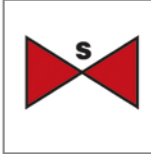
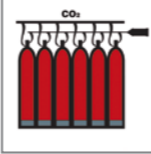

Break Glass In Emergency MM CAI CA4329D	Escape Ladder MM CAI CA4312D	Helideck MM CAI CA4316D	Safety Arrow Straight MM CAI CA4322D
Escape Ladder MM CAI CA6571C	Shower MM CAI CA4108C	Exit/run Left/arrow Up/left MM CAI CA4601S	Exit Left-man Run Right-arrow Up MM CAI CA4602S
Exit Right-man Run Left-arrow Up/left MM CAI CA4603S	Exit Left-man Run Right-arrow Up/right MM CAI CA4604S	Exit Right-man Run Left-arrow Left MM CAI CA4605S	Exit Left-man Run Right-arrow Right MM CAI CA4606S
Exit Right-man Run Left-arrow Down/left MM CAI CA4607S	Exit Left-man Run Right-arrow Down/right MM CAI CA4608S	Exit/run Left/arrow Left Down MM CAI CA4609S	Exit Left-man Run Right-arrow Down MM CAI CA4610S
Exit/run Man Left MM CAI CA4611S	Exit Left-man Run Right MM CAI CA4612S	Emergency Exit/run Man Left MM CAI CA4619Y	Emergency Exit/run Man Right MM CAI CA4618Y
Escape Route MM CAI CA4617T	Escape Hatch MM CAI CA4614T	Escape Door MM CAI CA4615T	Escape Window MM CAI CA4616T







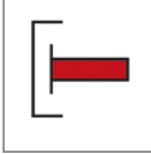
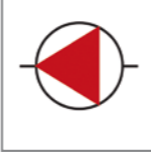

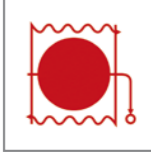





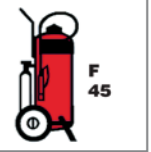









 Lifeboat with arrow Up Left MM CAI CA4626D	 Lifeboat with arrow Up Right MM CAI CA4632D	 Lifeboat with arrow diagonally Up Left MM CAI CA4627D	 Lifeboat with arrow diagonally Up Right MM CAI CA4630D
 Lifeboat with arrow Left MM CAI CA4624D	 Lifeboat with arrow Right MM CAI CA4631D	 Lifeboat with arrow diagonally Down Left MM CAI CA4628D	 Lifeboat with arrow diagonally Down Right MM CAI CA4629D
 Lifeboat with arrow Down Left MM CAI CA4625D	 Lifeboat with arrow Down Right MM CAI CA4633D	 Straight Arrow MM CAI CA6551C	 Diagonal Arrow MM CAI CA6552C
 Emergency Door Operation Push to open MM CAI CA4647D	 Emergency Door Operation Pull to open MM CAI CA4648D	 Slide To Open Left MM CAI CA4645D	 Slide To Open Right MM CAI CA4646D
 Refuge Point MM CAI CA4111C	 Refuge Point Left MM CAI CA4662Y	 Refuge Point Right MM CAI CA4661Y	 Mobility Impaired Sign MM CAI CA4665D
 Exit MM CAI CA4109C	 Exit MM CAI CA4621Y	 Man Run Right MM CAI CA6572C	 Exit Person Left MM CAI CA6573C

 Manually Operated Call Point MM CAI CAFCS304C	 Foam Fire Extinguisher MM CAI CAFCS279C	 Space Or Group Of Spaces Protected By Foam Fire Extinguishing System MM CAI CAFCS294C	 Space Or Group Of Spaces Protected By CO2 Fire Extinguishing System MM CAI CAFCS293C
 Space Or Group Of Spaces Protected By Gas other than CO2 Fire Extinguishing System MM CAI CAFCS295C	 Space Or Group Of Spaces Protected By Powder Fire Extinguishing System MM CAI CAFCS296C	 Space Or Group Of Spaces Protected By Water Fire Extinguishing System MM CAI CAFCS297C	 Space Or Group Of Spaces Protected By Sprinkler or High Pressure Water Fire Ext. System MM CAI CAFCS298C
 Safety Plan MM CAI CAFCS092C	 Fire Control Plan MM CAI CAFCS001C	 Push-Button / Switch for Fire Alarm MM CAI CAFCS002C	 Horn Fire Alarm MM CAI CAFCS004C
 Bell Fire Alarm MM CAI CAFCS003C	 Manually Operated Call Point MM CAI CAFCS005C	 Space Protected By Automatic Firealarm MM CAI CAFCS006C	 Space Protected By CO2 MM CAI CAFCS007C
 CO2 Horn MM CAI CAFCS008C	 CO2 Release Station MM CAI CAFCS009C	 Halon 1301 Battery MM CAI CAFCS010C	 Space Protected By Halon 1301 MM CAI CAFCS011C
 Halon Horn MM CAI CAFCS012C	 Foam Installation MM CAI CAFCS013C	 Foam Monitor (Gun) MM CAI CAFCS014C	 Foam Nozzle MM CAI CAFCS015C

 Space Protected By Foam MM CAI CAFCS016C	 Foam Valve MM CAI CAFCS017C	 Foam Release Station MM CAI CAFCS018C	 Emergency Fire Pump MM CAI CAFCS019C
 Remote Controlled Fire Pumps or Emergency Switches MM CAI CAFCS020C	 Bilge Pump MM CAI CAFCS021C	 Emergency Bilge Pump MM CAI CAFCS022C	 Water Monitor (Gun) MM CAI CAFCS023C
 Water Fog Applicator MM CAI CAFCS024C	 Emergency Telephone Station MM CAI CAFCS025C	 Fire Axe MM CAI CAFCS026C	 Drenching Installation MM CAI CAFCS027C
 Space Protected By Drenching System MM CAI CAFCS028C	 Section Valves Drenching MM CAI CAFCS029C	 Fire Station MM CAI CAFCS030C	 'A' Class Division MM CAI CAFCS031C
 'A' Class Fire Door MM CAI CAFCS032C	 'A' Class Fire Door Self Closing MM CAI CAFCS033C	 'A' Class Fire Door MM CAI CAFCS034C	 'A' Class Fire Door Self-closing MM CAI CAFCS035C
 Portable Foam Applicator MM CAI CAFCS036C	 'B' Class Division MM CAI CAFCS037C	 'B' Class Fire Door MM CAI CAFCS038C	 'B' Class Fire Door Self Closing MM CAI CAFCS039C

























 'B' Class Fire Door MM CAI CAFCS040C	 'B' Class Fire Door Self-Closing MM CAI CAFCS041C	 Main Vertical Zone MM CAI CAFCS042C	 Fire Alarm Panel MM CAI CAFCS043C
 Sprinkler Installation MM CAI CAFCS044C	 Space Protected By Sprinkler MM CAI CAFCS045C	 Sprinkler Horn MM CAI CAFCS046C	 Sprinkler Section Valve MM CAI CAFCS047C
 CO2 Battery MM CAI CAFCS048C	 Halon Release Station MM CAI CAFCS049C	 Halon 1301 Bottles In Protected Area MM CAI CAFCS050C	 Powder Installation MM CAI CAFCS051C
 Powder Monitor MM CAI CAFCS052C	 Powder Hose and Hand Gun MM CAI CAFCS053C	 Powder Release Station MM CAI CAFCS054C	 Flame Detector MM CAI CAFCS055C
 Smoke Detector MM CAI CAFCS056C	 Fire Main With Valves MM CAI CAFCS057C	 Hose Box With Spray/Jet MM CAI CAFCS058C	 International Shore Connection MM CAI CAFCS059C
 Fire Pump MM CAI CAFCS060C	 Heat Detector MM CAI CAFCS061C	 Gas Detector MM CAI CAFCS062C	 Fire Damper In Vent Duct MM CAI CAFCS063C

 Remote Controlled Skylights MM CAI CAFCS064C	 Remote Controlled Fuel / Lubricating Oil Valves MM CAI CAFCS065C	 Control Station MM CAI CAFCS066C	 Locker With Fireman's Outfit MM CAI CAFCS067C
 Locker With Additional Breathing Apparatus MM CAI CAFCS068C	 Locker With Additional Protective Clothing MM CAI CAFCS069C	 Primary Means Of Escape MM CAI CAFCS070C	 Secondary Means Of Escape MM CAI CAFCS071C
 Closing Appliance For Ext. Ventilator Inlet and Outlet MM CAI CAFCS072C	 Inert Gas Installation MM CAI CAFCS073C	 High Expansion Foam Supply Tank MM CAI CAFCS074C	 CO2 Nitrogen Bulk Installation MM CAI CAFCS075C
 Emergency Generator MM CAI CAFCS076C	 Emergency Switchboard MM CAI CAFCS077C	 Remote Ventilation Shutoff MM CAI CAFCS078C	 Powder Fire Extinguisher MM CAI CAFCS079C
 Foam Fire Extinguishers MM CAI CAFCS080C	 Halon 1211 Fire Extinguisher MM CAI CAFCS082C	 CO2 Fire Extinguisher MM CAI CAFCS083C	 Powder Fire Extinguisher MM CAI CAFCS085C
 CO2 Fire Extinguisher MM CAI CAFCS084C	 Powder Fire Extinguisher MM CAI CAFCS086C	 Wheeled Powder Fire Extinguisher MM CAI CAFCS087C	 Wheeled CO2 Fire Extinguisher MM CAI CAFCS088C

 Powder Fire Extinguisher MM CAI CAFCS287C	 Foam Fire Extinguisher MM CAI CAFCS081C	 Spare Charges for Fire Extinguisher MM CAI CAFCS098C	 Wheeled Foam Fire Extinguisher MM CAI CAFCS091C
 Fire Arrow MM CAI CA6555C	 Fire Arrow MM CAI CA6556C	 Fire Extinguisher MM CAI CA5101C	 Fire Alarm MM CAI CA5102C
 Fire Hose Reel MM CAI CA5103C	 Fire Point MM CAI CA5104C	 Fire Phone MM CAI CA5105C	 Fire Extinguisher MM CAI CA5152E
 Fire Alarm MM CAI CA5153E	 Fire Hose Reel MM CAI CA5154E	 Fire Point MM CAI CA5155E	 Fire Phone MM CAI CA5105E
 Fire Extinguisher MM CAI CA5106D	 Fire Alarm MM CAI CA5107D	 Fire Alarm Call Point MM CAI CA5108D	 In Case of Fire Break Glass MM CAI CA5109D
 Fire Hose MM CAI CA5110D	 Fire Hose Reel MM CAI CA5111D	 Open Valve Before Running Out Hose MM CAI CA5134D	 Fire Point MM CAI CA5112D



 Fire Fighting Equipment Stored Inside MM CAI CA5114D	 Fire Blanket MM CAI CA5115D	 To Be Used Only in Case of Fire MM CAI CA5131D	 Sprinkler Stop Valve MM CAI CA5132D
 Sprinkler Control Valve MM CAI CA5120D	 Open This Valve in Event of Fire MM CAI CA5133D	 Foam Inlet MM CAI CA5156D	 Fire Telephone MM CAI CA5118D
 Firemans Suit MM CAI CA5117D	 Fire Pump Start Button MM CAI CA5119D	 Fire Flap MM CAI CA5121D	 For Use on Any Fires MM CAI CA5135D
 For Use on Flammable Liquid Fires MM CAI CA5136D	 For Use on Electrical Fires MM CAI CA5137D	 Number "0" MM CAI CA6630A	 Number "1" MM CAI CA6631A
 Number "2" MM CAI CA6632A	 Number "3" MM CAI CA6633A	 Number "4" MM CAI CA6634A	 Number "5" MM CAI CA6635A
 Number "6" MM CAI CA6636A	 Number "7" MM CAI CA6637A	 Number "8" MM CAI CA6638A	 Number "9" MM CAI CA6639A

 In Case of Fire Use Stairs MM CAI CA5128F-AL	 Missing MM CAI CA5140L-AL	 Fire Extinguisher Water MM CAI CA5122E	 Fire Extinguisher Foam MM CAI CA5123E
 Fire Extinguisher Powder MM CAI CA5124E	 Fire Extinguisher CO2 MM CAI CA5125E	 Fire Blanket MM CAI CA5126E	 Fire Extinguisher Double Face MM CAI CA5148Y-RL
 Fire Alarm Double Face MM CAI CA5149Y-RL	 Fire Hose Reel Double Face MM CAI CA5147Y-RL	 Fire Point Double Face MM CAI CA5146Y-RL	 Attention MM CAI CA4815C
 Wear Helmet MM CAI CA4806C	 High Visibility Clothing MM CAI CA4841C	 Wear Goggles MM CAI CA4803C	 Wear Face Shield MM CAI CA4808C
 Wear Mask MM CAI CA4807C	 Wear Respirator MM CAI CA4805C	 Wear Ear Protection MM CAI CA4804C	 Wear Gloves MM CAI CA4801C
 Wear Boots MM CAI CA4802C	 Wear Protective Clothing MM CAI CA4839C	 Wear Safety Harness MM CAI CA4846C	 Lift Correctly MM CAI CA4813C

 Wash Your Hands MM CAI CA4811C	 Guards Must Be In Position Before Starting MM CAI CA4809C	 Lifejackets MM CAI CA4840C	 Think Safety MM CAI CA4726D
 Protective Clothing Must Be Worn In This Area MM CAI CA4723D	 Personal Protective Equipment is Provided Use It MM CAI CA4724D	 Comply With Regulations MM CAI CA4722D	 Wear Helmet MM CAI CA4819E
 Head Protection Must Be Worn MM CAI CA4818E	 Eye Protection Must Be Worn MM CAI CA4823E	 Wear Goggles MM CAI CA4843E	 Wear Face Shield MM CAI CA4825E
 Wear Mask MM CAI CA4834E	 Ear Protection Must Be Worn in This Area MM CAI CA4830E	 Ear Protection Must Be Worn MM CAI CA4832E	 Wear Ear Protection MM CAI CA4831E
 Wear Gloves MM CAI CA4816E	 Boots Must Be Worn MM CAI CA4815E	 Wear Protective Clothing MM CAI CA4842E	 Lift Correctly MM CAI CA4821E
 Now Wash Your Hands MM CAI CA4828E	 Guards Must Be in Position Before Starting MM CAI CA4820E	 Eye Protection Is Provided For Your Safety & Must Be Worn MM CAI CA4822E	 Wear Respirator MM CAI CA4833E

 Face Protection Must Be Worn in This Area MM CAI CA4839E	 This Is A Safety Helmet Area MM CAI CA4817E	 Eye Protection Must Be Worn in This Area MM CAI CA4824E	 Face Protection Must Be Worn When Welding MM CAI CA4826E
 Lifejacket Must Be Worn At All Times MM CAI CA4836E	 High Visibility Clothing Must Be Worn MM CAI CA4837E	 Keep Clear Exit For Emergency Escape Route MM CAI CA4721C	 This Door Must Be Kept Closed MM CAI CA4720C
 Keep Clear MM CAI CA4719C	 Close This Door At Night MM CAI CA4718C	 Close These Doors At Night MM CAI CA4717C	 This Door To Be Kept Locked When Not In Use MM CAI CA4716C
 To Be Kept Unlocked During Working hours MM CAI CA4715C	 Fire Door Keep Locked Shut MM CAI CA4714C	 Automatic Fire Door Keep Clear MM CAI CA4713C	 Staircase Must Be Kept Clear At All Times MM CAI CA4712C
 Fire Escape Keep Clear MM CAI CA4711C	 Gangway Keep Clear MM CAI CA4710C	 Fire Door Keep Shut MM CAI CA4709C	 Keep Locked Shut When Not In Use MM CAI CA4708C
 Keep Clear When Door Is Closing MM CAI CA4707C	 This Hatch Must Be Kept Closed At Sea MM CAI CA4706C	 This Door Must Be Kept Closed At Sea MM CAI CA4705C	 Watertight Door Keep Shut MM CAI CA4704C

 <p>Automatic Watertight Door Keep Clear MM CAI CA4703C</p>	 <p>Ensure This Door Is Fully Closed MM CAI CA4702C</p>	 <p>Exit Keep Clear MM CAI CA4701C</p>	 <p>Emergency Exit Keep Clear MM CAI CA4727S</p>
 <p>Escape Route Keep Clear At All Times MM CAI CA473S</p>	 <p>Accidents Must Be Reported MM CAI CA4725D</p>	 <p>Ventilation To Be Used Prior To Entry MM CAI CA4738D</p>	 <p>No Fire Loop Isolated MM CAI CA4742D</p>
 <p>All Visitors To Report To Duty Officer MM CAI CA4743D</p>	 <p>Keep Clear MM CAI CA4734E</p>	 <p>Keep Shut MM CAI CA4735E</p>	 <p>When Plant Is Not in Use Gas Cylinder Valves Shall Be Shut MM CAI CA4736E</p>
 <p>Adjust Pressure According To The Torch In Use MM CAI CA4746E</p>	 <p>Secure Painter To Strong Point Before Launching MM CAI CA4747E</p>	 <p>Emergency Evacuation Instructions MM CAI CA4739M</p>	 <p>Emergency Instructions For Passengers MM CAI CA4740M</p>
 <p>Man Overboard MM CAI CA4732E</p>	 <p>Emergency Evacuation Instructions MM CAI CA4731E</p>	 <p>Keep Locked MM CAI CA4848E</p>	 <p>Stack Goods Correctly MM CAI CA4850E</p>

**Contact us for special and customised IMO signs.**

**SAFETY AWARENESS & TRAINING POSTERS**  
and other IMO symbols with or without text also available.

## DIRECTION FLOW TAPES

### PIPE IDENTIFICATION TAPES

Pipes marking system in accordance with ISO 14726 (1-2), BS 1710 and BS 4800 regulations.

**Material: vinyl tapes**  
**Dimensions: rolls 50 MM x 50 MT**

 <p>Dark Green MM CAI CA9101</p>	 <p>Grey MM CAI CA9102</p>	 <p>Maroon MM CAI CA9103</p>	 <p>Yellow Ocre MM CAI CA9104</p>
 <p>Violet MM CAI CA9105</p>	 <p>Light Blue MM CAI CA9106</p>	 <p>Black MM CAI CA9107</p>	 <p>Orange MM CAI CA9108</p>
 <p>Red MM CAI CA9111</p>	 <p>Crimson MM CAI CA9114</p>	 <p>Emerald Green MM CAI CA9115</p>	 <p>White MM CAI CA9117</p>
 <p>Blue MM CAI CA9118</p>	 <p>Golden Brown MM CAI CA9120</p>	 <p>Flow Arrows MM CAI CA9130</p>	 <p>Silver MM CAI CA9131</p>















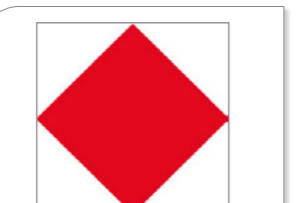

FLAGS

FABRIC	INTERNATIONAL CODE FLAGS*, STANDARD SIZES (cm)	NATIONAL AND MERCHANT FLAGS, STANDARD SIZES (cm)
100% Polyester bunting	20x30 30x45 40x60 50x75 70x100 80x120 100x150 130x200 150x225 200x300	20x30 30x45 40x60 50x75 60x73 80x98 80x120 100x150 120x160 140x170

Custom sizes, different fabric, special embroidery available on request.  
\*International Code Flags or Signaling Flags can be sold both singularly and in sets.

INTERNATIONAL  
CODE FLAGS

 <b>A</b>	 <b>B</b>	 <b>C</b>
 <b>D</b>	 <b>E</b>	 <b>F</b>
 <b>H</b>	 <b>I</b>	 <b>J</b>
 Alfa flag Diver Down Keep Clear	 Bravo flag Dangerous Cargo	 Charlie flag Yes
 Delta flag Keep Clear	 Echo flag Altering Course to Starboard	 Golf flag Want a Pilot
 Hotel flag Pilot on Board	 India flag Altering Course to Port	 Kilo flag Desire to Communicate



 <b>L</b>	 <b>M</b>	 <b>N</b>	 <b>O</b>
 <b>P</b>	 <b>Q</b>	 <b>R</b>	 <b>S</b>
 <b>T</b>	 <b>U</b>	 <b>V</b>	 <b>W</b>
 <b>X</b>	 <b>Y</b>	 <b>Z</b>	
 Lima flag Stop Instantly	 Mike flag I am Stopped	 November flag No	 Oscar flag Man Overboard
 Papa flag About to Sail	 Quebec flag Request Pratique	 Romeo flag Boat Signal Procedure	 Sierra flag Engines Going Astern
 Tango flag Keep Clear	 Uniform flag Standing into Danger	 Victor flag Require Assistance	 Whiskey flag Require Medical Assistance
 Xray flag Stop Your Intention	 Yankee flag Am Dragging Anchor	 Zulu flag Require a Tug	 Answering flag Code Pennant
 Number 0 flag	 Number 1 flag	 Number 2 flag	 Number 3 flag
 Number 4 flag	 Number 5 flag	 Number 6 flag	 Number 7 flag



Contact us  
for other type or country flags

ALL OUR PRODUCTS  
ARE DISTRIBUTED IN EVERY  
**CAPTAIN MARINE STORE**

[www.captainmarine.it](http://www.captainmarine.it)  
Find your nearest CMS



# PUBLICATIONS

## IMO PUBLICATIONS

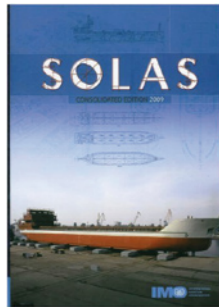

SOLAS Consolidated Edition  
Code: MM CAI IE110E

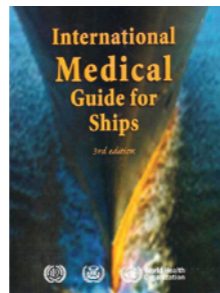

ILO/IMO/WHO  
International medical guide for ships  
Code: MM CAI I115E



International Safety Management Code (ISM Code) and guidelines on implementation of the ISM code  
Code: MM CAI IB117E



Guide to maritime security and the ISPS code  
Code: MM CAI IA116E



International code for fire safety systems (FSS Code)  
Code: MM CAI IA155E

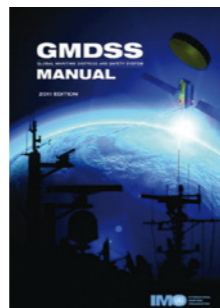

Global maritime distress and safety system manual (GMDSS Manual)  
Code: MM CAI IE970E



International life-saving appliances code (LSA Code)  
Code: MM CAI ID982E



International code of signals  
Code: MM CAI IA994E



Imo standard marine communication phrases (IMO SMCP)  
Code: MM CAI IA987E



MARPOL Consolidated Edition  
Code: MM CAI IC520E

AMENDMENTS are issued periodically, ask for availability



Other editors publications available on request

### Marine Guidance Notes (MGN)

Full list of MCA Guidance publications available at releasing date, regularly update with latest notes

## LOG BOOKS



Chief Officer Log Book Clutha 3 Months  
Code: MM CAI BR200



Chief Officer Log Book Clutha 6 Months  
Code: MM CAI BR201



Compass Log Book  
Code: MM CAI REG067

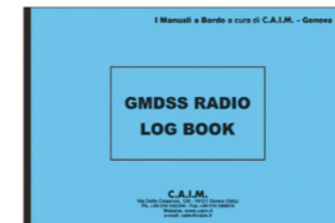

GMDSS Radio Log Book  
Code: MM CAI REG080



Medical Log Book  
Code: MM CAI REG063



Garbage Log Book  
Code: MM CAI REG044



Visitors Log Book  
Code: MM CAI REG007



Wish List \_\_\_\_\_

\_\_\_\_\_

\_\_\_\_\_

\_\_\_\_\_

\_\_\_\_\_

\_\_\_\_\_

\_\_\_\_\_

\_\_\_\_\_

\_\_\_\_\_

\_\_\_\_\_

\_\_\_\_\_

\_\_\_\_\_

\_\_\_\_\_

\_\_\_\_\_

\_\_\_\_\_

\_\_\_\_\_

\_\_\_\_\_

\_\_\_\_\_

\_\_\_\_\_

\_\_\_\_\_

\_\_\_\_\_

\_\_\_\_\_

\_\_\_\_\_

\_\_\_\_\_

Drawings / Sketches

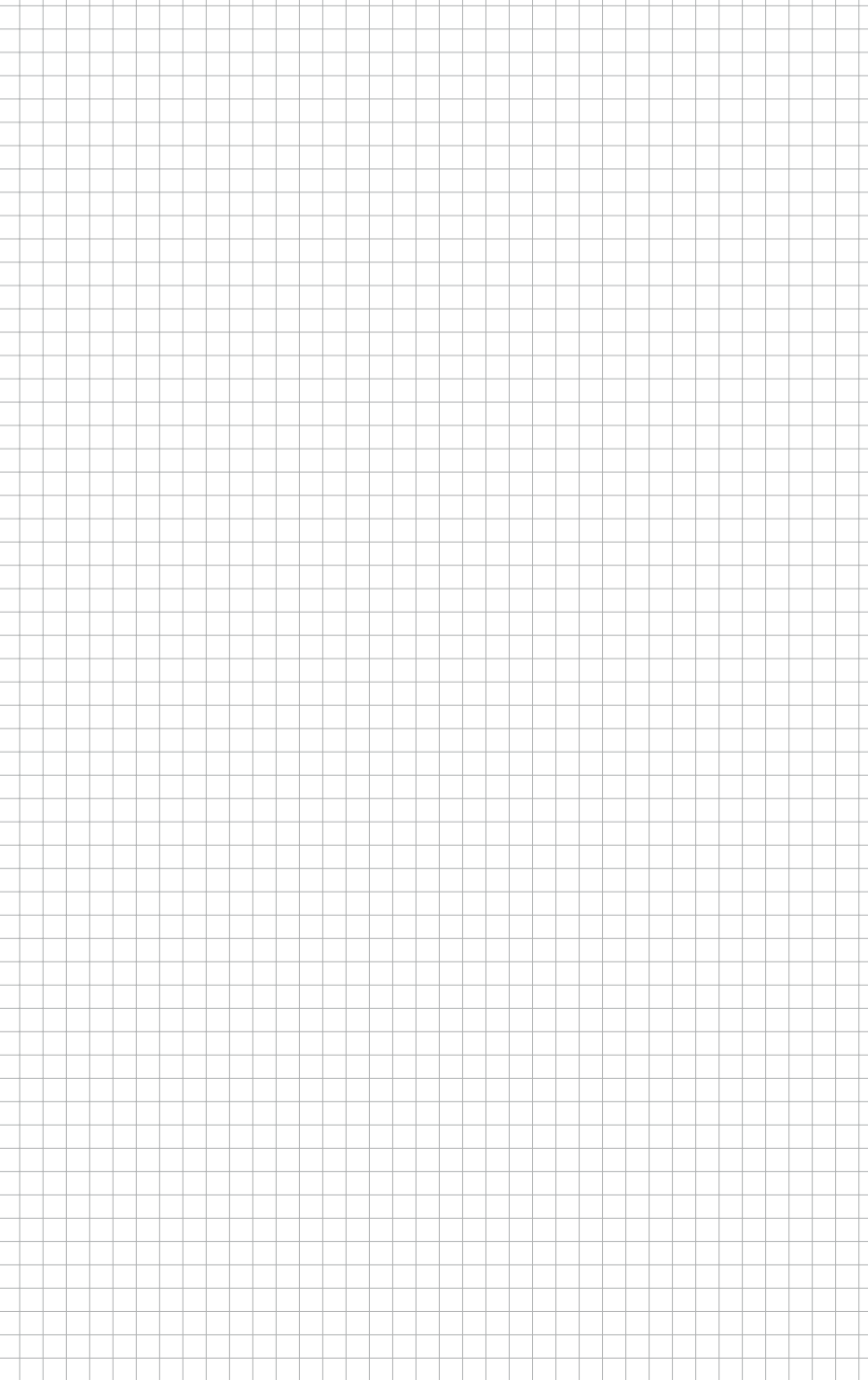

Memo .....

.....

.....

.....

.....

.....

.....

.....